



Gasket Design Criteria Table of Contents

	<i>Page</i>
Worldwide Customer Service Network	2
Introduction	3
Section I - Gasket Selection	4
Soft Cut Gaskets	6
Thermiculite™	7
PTFE Products - Sigma™	9
PTFE Products - Fluoroseal™	11
Flexitallic Flexicarb®	12
Compressed Non-asbestos Fiber Gaskets	13
Sheet Materials Chemical Compatibility Selector Guide	14
Sheet Materials Chemical Compatibility Chart	15
Insulating Sets	17
Metal Jacketed Gaskets	18
Spiral Wound Gaskets	21
Sizing Parameters for Spiral Wound Gaskets	28
Flexpro™ Gaskets	30
MRG Gaskets	31
Ring Type Joints	32
Specialized Ring Type Joints	34
Lens Rings	35
Weld Gaskets	36
Section II - Joint Integrity Calculations	37
ASME Boiler & Pressure Vessel Code Calculations	38
PVRC Method	42
Section III - Gasket Installation	44
Bolt Torque Sequence	46
Troubleshooting	47
Metallic Gasket Materials	49
Useful Material Data	51
Bolting Data	52
Useful Technical Data	54
Torque Required To Produce Bolt Stress	56
Ordering Flexitallic Gaskets for Special Flange Designs	57
Metric Unit Conversions	59
Terms	60

Worldwide Customer Service Network

◆ Owned Manufacturing Plants

Flexitallic Ltd.
Cleckheaton, Yorkshire, UK
Tel: +44 1274 851273

Flexitallic Ltd.
Rochdale, Lancashire, UK
Tel: +44 1274 851273

Flexitallic L.P.
Houston, Texas, USA
Tel: +1 281 604 2400

Flexitallic Canada
Ontario, Canada
Tel: +1 519 332 8300

● Joint Ventures

Equiter S.A. de C.V.
Guadalajara, Mexico
Tel: +52 3 612 8483

Flexitallic de Venezuela S.A.
Caracas, Venezuela
Tel: +58 2 41 783550

▲ Branch Offices & Warehouses

Flexitallic Ltd.
Aberdeen, Scotland, UK
Tel: +44 1224 725241

Flexitallic GmbH
Burscheid, Germany
Tel: +49 2174 8950

Flexitallic L.P.
Cherry Hill, New Jersey, USA
Tel: +1 856 321 9301

Flexitallic L.P.
Chicago, Illinois, USA
Tel: +1 630 268 0418

Flexitallic Ltd.
Singapore 048581
Tel: +65 6 321 9112

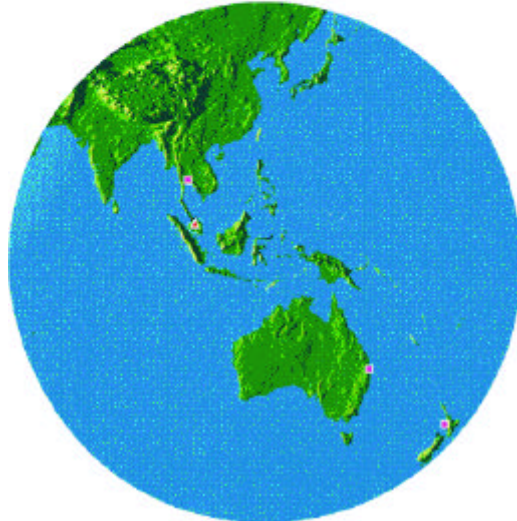

■ Licensees

ACL Specialised Gaskets Pty. Ltd.
Brisbane, Australia
Tel: +61 73 268 0666

AGS Group Inc.
Edmonton, Alberta, Canada
Tel: +1 780 466 5050

Arne Bo Pedersen
Stavanger, Norway
Tel: +47 5185 9000

Automotive Components N.Z.
Auckland, New Zealand
Tel: +64 98284119

Dragon Industrial Services
Pembroke, UK
Tel: +44 1646 622200

Eriks BV.
Rotterdam, Netherlands
Tel: +31 72 514 1514

FMI Sima S.R.L.
Brescia, Italy
Tel: +39 030 7386 033

Goldcrest Engineering & Service Co.
(GESCO)
Pataya, Chonburi, Thailand
Tel: +1 66 38 716 716

Henry Gallacher Ltd.
Stockton, Teesside UK
Tel: +44 1642 750111

Industrial Gasket & Supply
Torrance, California, USA
Tel: +1 310 530 1771

Lake Charles Rubber
Lake Charles, Louisiana, USA
Tel: +1 337 433 1002

Saudi Gasket Factory
Jeddah, Saudi Arabia
Tel: +996 2 665 2966

FLEXITALLIC GASKET DESIGN CRITERIA

Introduction

FLEXITALLIC, the world's leading manufacturer and supplier of static seals and the originator of the Spiral Wound Gasket, is committed to sealing solutions for today's industry. With greater emphasis than ever before placed on joint tightness, more attention is focused toward variables associated with the integrity of the bolted gasketed joint. Flexitallic Gasket Design Criteria manual offers the engineer and end user assistance in meeting the goal of providing fundamentally sound static sealing practice. Developed and collated by Flexitallic's worldwide team of engineers, this publication is the "engineer's handbook" of static seals technology.

Flexitallic has identified three factors which must be considered to achieve a leaktight joint

- Gasket Selection
- Gasket Design
- Gasket Installation

The Gasket

A gasket is a compressible material, or a combination of materials, which when clamped between two stationary members prevents the passage of the media across those members.

The gasket material selected must be capable of sealing mating surfaces, resistant to the medium being sealed, and able to withstand the application temperatures and pressures.

How Does It Work?

A seal is effected by the action of force upon the gasket surface. This force which compresses the gasket, causes it to flow into the flange macro and micro imperfections. The combination of contact stress, generated by the applied force between the gasket and the flange, and the densification of the gasket material, prevents the escape of the confined fluid from the assembly.

Flange Imperfections

On seating, the gasket must be capable of overcoming the macro and micro imperfections. Macro defects are imperfections such as flange distortions, non-parallelism, scoring, troughs, while superficial imperfections such as minor scratches and minor scores are considered micro imperfections.

Forces On The Gasket

In order to ensure the maintenance of the seal throughout the life expectancy of the assembly, sufficient stress must remain on the gasket surface to prevent leakage. The residual bolt load on the gasket should at all times be greater than the hydrostatic end force acting against it.

The hydrostatic end force is the force produced by the internal pressure which acts to separate the flanges.

Considerations For Gasket Selections

Many factors should be considered when selecting a gasket to ensure its suitability for the intended application. Gasket properties as well as flange configuration and application details are part of the selection process.

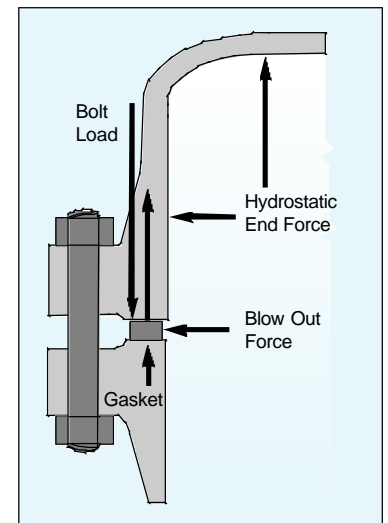
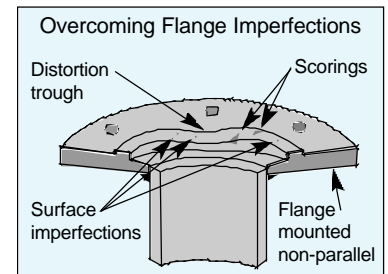

Internal Pressure is exerted against both the flange and the gasket.

SECTION I

Gasket Selection

Gaskets can be classified into three categories: soft cut, semi-metallic and metallic types.

The physical properties and performance of a gasket will vary extensively, depending on the type of gasket selected and the materials from which it is manufactured.

Physical properties are important factors when considering gasket design and the primary selection of a gasket type is based on the following:

- Temperature of the media to be contained
- Pressure of the media to be contained
- Corrosive nature of the application
- Criticality of the application

Soft Cut

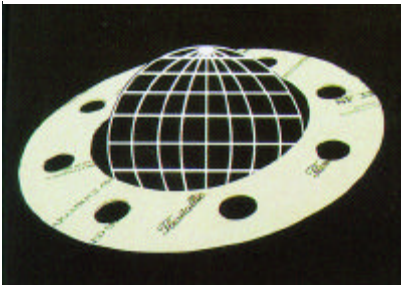

Sheet materials are used in low to medium pressure services. With careful selection these gaskets are not only suitable for general service but also for extreme chemical services and temperatures.

Types: Non-asbestos Fiber Sheets, PTFE, Biaxially Orientated Reinforced PTFE, Graphite, Thermiculite, Insulating Gaskets.

Semi-metallic

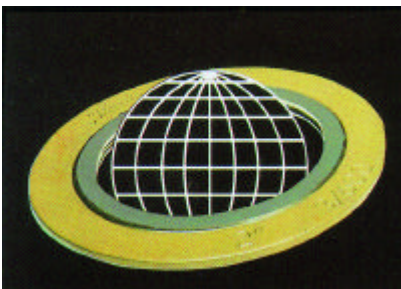

These are composite gaskets consisting of both metallic and non-metallic materials. The metal provides the strength and the resilience of the gasket and the non-metallic component provides the conformable sealing material. These gaskets are suitable for low and high pressure and temperature applications. A wide range of materials is available.

Types: Spiral Wound Gaskets, Flexpro Gaskets (covered serrated metal core), Metal Jacketed Gaskets, MRG's (metal reinforced gaskets).

Metallic

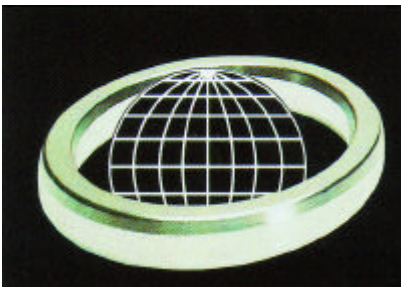

These gaskets can be fabricated in a variety of shapes and sizes recommended for use in high pressure/temperature applications. Except for weld ring gaskets, high loads are required to seat metallic gaskets, as they rely on the deformation or coining of the material into the flange surfaces.

Types: Ring Type Joints, Lens Rings, Weld Rings, Solid Metal Gaskets.

Gasket Selection

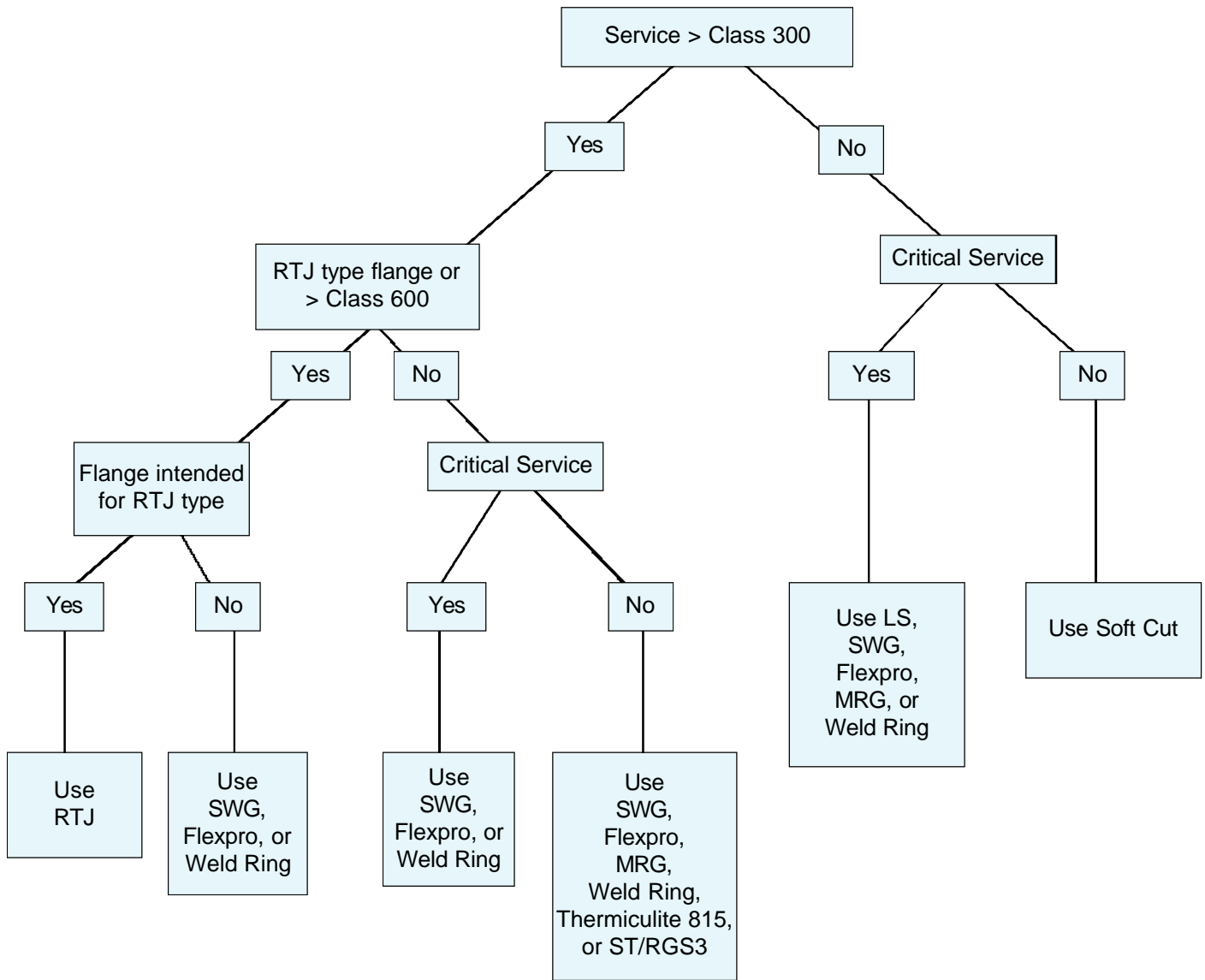

Select sealing material and metal type (when appropriate) on basis of service, temperature, and nature of medium.

Soft cut gaskets should always be of the minimum thickness consistent with the state of the flanges to be sealed, and compatible with the medium.

Soft Cut Gaskets

Compressed Asbestos Fiber (CAF) gaskets served industry's needs for many years. With the shift to non-asbestos gaskets, gasket manufacturers have developed a myriad of replacement products. Some of the initial materials developed proved inferior to their asbestos based predecessors in regard to temperature, chemical resistance, creep resistance and sealing characteristics.



More recently Flexitallic has developed non-asbestos gasket sheet products approaching, and in some instances surpassing the capabilities of asbestos sheet gaskets. Some of these products have been fiber reinforced grades, manufactured by the traditional calendering or sheeter process. Other product ranges are fiber-free and some of these materials have exceptionally good properties which exceed the capabilities of CAF.

Flexitallic **Thermiculite** is a high temperature gasket material based upon the mineral vermiculite. The product is reinforced with a metal core and is designed for use at temperatures which exceed the capability of graphite based sheets. The temperature capability of CAF is also exceeded by Thermiculite.

The Flexitallic **Sigma** range of biaxially orientated PTFE products has superb chemical resistance, far exceeding that of CAF. These materials can be used at temperatures from cryogenic to 260°C (500°F). Being intrinsically clean they are especially suitable for use in the food, pharmaceutical and electronics industries.

Flexicarb is the name given to Flexitallic's range of graphite based products. The range includes graphite foil as well as graphite laminates which contain reinforcing metal cores to overcome the fragility of the non-reinforced foil. Graphite products have excellent stress retention properties and are resistant to most chemical media with the exception of strong oxidizing agents. Reinforced Flexicarb sheets are the standard sealing product for many arduous applications in the petrochemical and refining industries.

The Flexitallic **SF** and **AF** product ranges are rubber bound, fiber reinforced sheets made by the traditional calendering or sheeter process. A wide range of fiber types are used, often in combination, ranging from cellulose, rockwool and glass to aramid and carbon.

Soft cut gasket sheets are typically used in Class 150 or Class 300 flanges; some of the metal reinforced products can also be used in higher classes. The temperature capability of the fiber/rubber products is highly thickness dependent, with thin gaskets having a wider service envelope than thicker ones.

Thermiculite[®]

Exclusive to Flexitallic, Thermiculite sheet sealing materials are comprised of both chemically and thermally exfoliated vermiculite reinforced with a metallic core. Vermiculite, a naturally occurring mineral with a plate-like structure, demonstrates a much broader range of chemical resistance than graphite but, more importantly, superior high temperature sealing characteristics.

Graphite's stress-loss due to oxidation effects has led to many examples of gasket failure. Independent testing indicated a temperature limit of 340°C (650°F) for continuous service over 5 years. Thermiculite however is thermally stable and maintains its integrity even at extreme temperatures, ensuring against thermal oxidation (see graph on page 8). Independent testing at TTRL (Tightness, Testing, and Research Laboratory), Montreal illustrates Thermiculite's excellent sealing properties.

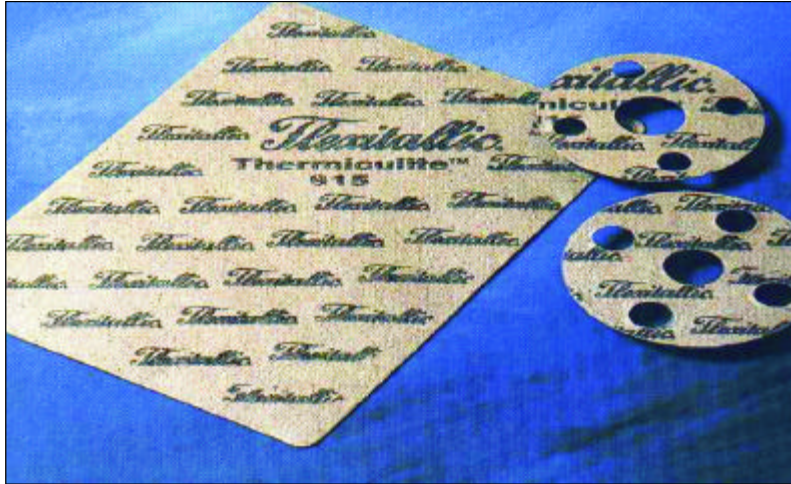

Thermiculite's high temperature capabilities make it an ideal choice for use in turbochargers and superchargers, diesel engine exhaust manifolds and oxidizing services in the nitrogen fertilizer manufacturing process, steam service, and many more. In addition, users with off-shore and seawater cooling applications will value Thermiculite's resistance to galvanic corrosion.

Thermiculite gaskets can be cut and installed using traditional methods: the modern techniques of water jet and laser cutting are also applicable to Thermiculite.

Thermiculite benefits from a high technical specification which makes it suitable for use even in demanding service conditions. A superb level of tightness is achieved even at 500°C (930°F) and the product maintains its overall effectiveness up to at least 870°C (1600°F).

Thermiculite is not affected by oxidation.

Product Range

Thermiculite 815 - Reinforced with a tanged 316 stainless steel core. Thermiculite 815 contains a low percentage of nitrile rubber binder. This rubber is cured using a sulfur-free curing system.

Thermiculite 816 - Differs from Thermiculite 815 only in the type of rubber binder used. A special grade of SBR is incorporated into Thermiculite 816 making it suitable for use in the high temperature processes of photographic film manufacture where "film fogging" can occur with other polymer types.

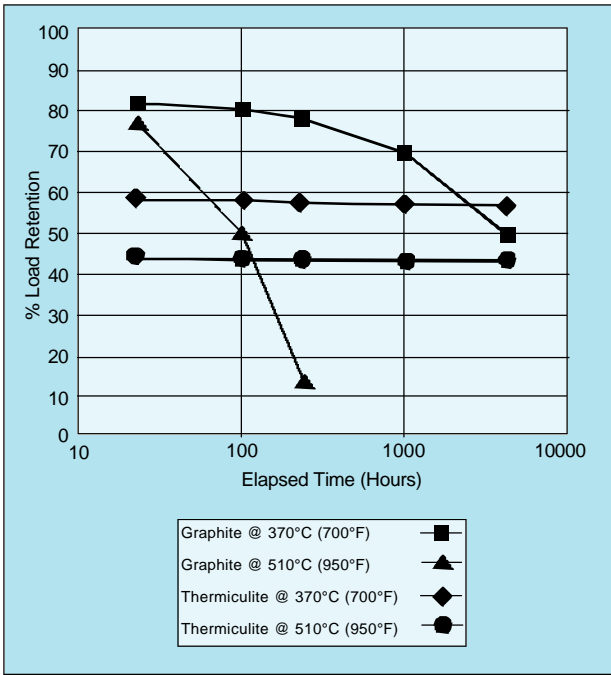

This graph illustrates that, unlike graphite, the load loss at operational temperatures does not increase with time.



Vermiculite's thin, flexible, soft plates can be exfoliated like graphite. They retain the sealability and low porosity of graphite, but Flexitallic's new Thermiculite sheet gaskets will not oxidize at high temperatures.

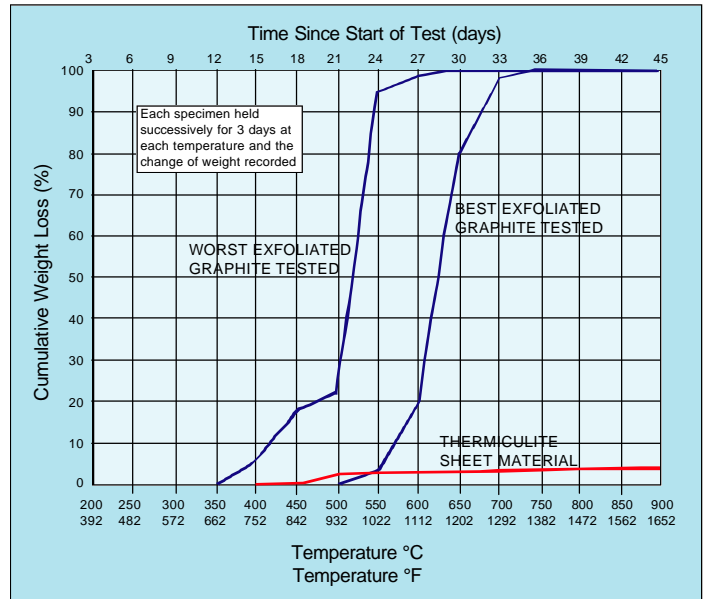

Cumulative Iso-thermal weight loss results for the best and worst exfoliated graphite tested

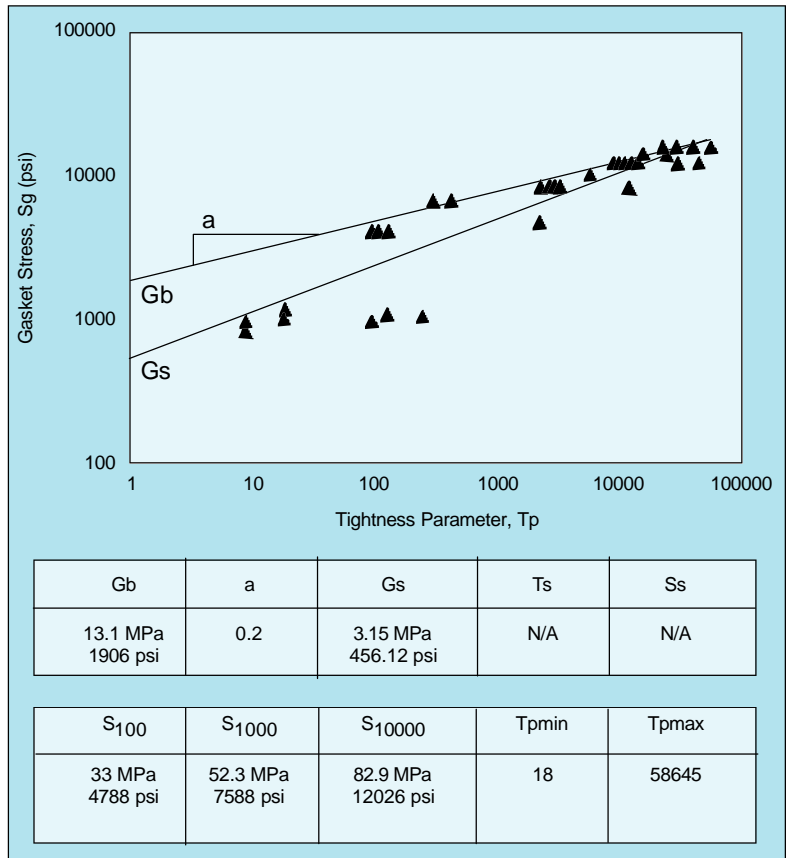

Room Temperature Tightness (ROTT) behavior characterization (Refer to page 41 for new method for determining factors.)

The above graphs are taken from the actual tests performed by TTRL.

PTFE Products - Sigma[®]

Flexitallic Sigma offers outstanding chemical resistance while the unique manufacturing process results in a biaxially fibrillated structure ensuring high seal integrity in the most demanding applications.

Pure PTFE sheet products are highly susceptible to creep relaxation which can be reduced by the incorporation of selected fillers (Filled PTFE). The maximum reduction in creep is achieved by combining these fillers in a biaxially orientated structure such as Sigma.

Flexitallic Sigma materials are inherently clean, making them suitable for use in industries where product contamination may be of concern such as food, pharmaceuticals and electronics. The components of the Flexitallic Sigma range comply with the requirements of FDA regulations and the materials' outstanding chemical resistance make them suitable for sealing virtually every chemical medium across the whole pH range (1 - 14).

Sigma products give unparalleled levels of sealing performance, especially when compared to conventional materials used in applications involving aggressive chemical media. These comparisons are supported by data generated by recognized, independent, international bodies in the field of static sealing. Sigma products are ideally suited for applications where seal integrity is paramount, an important consideration where stringent emission controls may be in force.

All products in the Flexitallic Sigma range are capable of sealing from cryogenic temperatures up to 260°C (500°F). For intermittent use even higher temperatures can be tolerated. Pressures from 8.5 MPa (1230 psi) down to vacuum can be accommodated. Furthermore, applications involving low gasket stresses such as glass lined, plastic and ceramic flanges, will not result in loss of sealing performance. These typically relate to the use of glass lined, plastic and ceramic flanges.

The Sigma range of products has been engineered to be user friendly:

- Materials can be cut easily using conventional tools and techniques
- Complex geometric shapes can be accommodated, including narrow cross sections
- Gaskets are easy to install and remove
- All products are non-toxic



Product Range

Sigma 500 - High compression sheet material specifically formulated for use on glass lined, plastic or ceramic flanges. Also suitable for use on flanges which are non-parallel, damaged or distorted. Sigma 500 seals under a lower bolt load than the other members of the Sigma product range.

Compatible with acids and alkalis at all but the highest concentrations. The high compressibility is achieved by the incorporation of hollow glass microspheres as the inorganic filler.

Sigma 511 - Standard compression sheet material reinforced with a silica filler. Intended for use with concentrated acids (except hydrofluoric acid) and with most general aggressive chemicals: also suitable for medium concentrations of alkalis.

Sigma 522/577 - These products have rigid cores of biaxially reinforced PTFE with soft, conformable surface layers of pure PTFE. Designed for use where low bolt loading is available.

Sigma 533 - Standard compression sheet material reinforced with barytes (barium sulphate) filler. Sigma 533 is the preferred choice for sealing concentrated alkalis and is also compatible with Aqueous Hydrofluoric Acid. Restricted resistance to concentrated mineral acids.

Sigma 544 - Available with a tanged 316 stainless steel reinforcement for enhanced pressure containment.

PTFE Products - Sigma^o

Properties

(ASTM Properties based on 1/32" thickness)

SIGMA Grade	500	511*	522	533	577
Composition PTFE	Glass Microspheres	Silica	Sigma 533 core w/microcellular PTFE faces	Barium Sulfate	Sigma 511 core w/microcellular PTFE Faces
Color	Blue	Fawn	White w/ Off White Core	Off White	White w/ Fawn Core
Density, g/cc	1.40	2.19	2.00	2.89	1.57
ASTM F 152 Tensile Strength (psi) Across Grain With grain	1740 1940	2175 2230	1220 1250	2260 2275	1220 1250
ASTM F146 Thickness Increase Oil #3 @ 300°F Fuel B @ 70°F	1% 2%	1% 1%	1% 1%	1% 1%	1% 1%
ASTM F146 Weight Increase Oil #3 @ 300°F Fuel B @ 70°F	3% 4%	2% 3%	12% 4%	1% 2%	12% 4%
ASTM F36A Compressibility	42%	10%	33.6%	11%	33.6%
ASTM F36A Recovery	40%	44%	23%	46%	23%
ASTM F38 Creep Relaxation	21%	23.9%	42%	16.8%	42%
ASTM F37A Sealability Fuel A @ 10 psi 1000 psi gasket stress	0.12 ml/hr	0.42 ml/hr	0.66 ml/hr	0.42 ml/hr	0.66 ml/hr
DIN 3754 N ₂ Permeability	0.02 ml/min	0.01 ml/min	0.01 ml/min	0.01 ml/min	0.01 ml/min
Maximum Pressure	940 - 1230 psi (depending on thickness)				
Maximum Temperature	500°F				
Gasket Constants					
Gb	4 psi	209 psi	472 psi	115 psi	N/A
a	0.804	0.356	0.25	0.382	N/A
Gs	0.115 psi	0.00498 psi	0.037 psi	0.000065 psi	N/A
Applications	All ingredients in all SIGMA grades comply with FDA requirements, all Sigma products can be cleaned for oxygen service.				
	Acids & caustics @ moderate concentrations, Hydrocarbons, Solvents, Hydrogen Peroxide, Low bolt loads, Glass lined flanges, In place of envelope gaskets	General service, Strong acids, Sulfuric acid, Solvents, Hydrocarbons, Steam, Chlorine, General Service	Hydrofluoric Acid, Warped or glass lined flanges, In place of envelope gaskets	Strong caustics, Moderate acids, Chlorine, Hydrocarbons, Food/pharmaceutical, Aqueous HF (Hydrofluoric Acid) @ max. conc. 49%, Aluminum Fluoride	Same as Sigma 511, Glass lined flanges, Lightly loaded flanges
Mis-applications	Anhydrous HF, Fluorine, Molten alkali metals, i.e. molten sodium, Potassium, Lithium, Bromine trifluoride, Chlorine trifluoride				
	Hydrogen fluoride gas, Aluminum fluoride	Hydrogen fluoride gas, Hydrofluoric acid, Black & green sulfate liquors, Caustic soda	Same as Sigma 533	Aqueous HF (hydrofluoric acid) @ conc. higher than 49%	Same as Sigma 511

*Also available with a tanged stainless steel - Sigma 544, color: fawn

PTFE Products

Fluoroseal[®]

Fluoroseal is an expanded, pure PTFE sealing material. Supplied in the form of a highly conformable, flexible strip, it is ideal for use in applications involving non-standard flanges. This material offers both versatility and convenience and is therefore often used as a backup sealing option in situations where conventional gaskets are not immediately available.

Flexitallic Fluoroseal has outstanding chemical resistance and is inherently clean, making the product particularly suitable for sealing against aggressive media or in situations where feedstock contamination may be of concern.

The presence of an adhesive backed strip simplifies installation in large or complex flange applications, such as air conveying and solvent recovery systems.



Widths and Thicknesses of Fluoroseal At Full Compression

Sealant Thickness	Sealant Width	Compressed Thickness	Compressed Width
1.5mm (1/16")	3mm (1/8")	0.3mm (0.010")	6mm (0.24")
2.0mm (3/32")	5mm (3/16")	0.4mm (0.015")	10mm (0.40")
2.5mm (3/32")	7mm (1/4")	0.45mm (0.018")	13mm (0.50")
4.0mm (5/32")	10mm (3/8")	0.55mm (0.022")	20mm (0.80")
5.0mm (3/16")	12.5mm (1/2")	0.8mm (0.031")	24mm (0.95")
5.0mm (3/16")	14mm (9/16")	0.8mm (0.031")	22mm (1.00")
6.0mm (7/32")	17mm (11/16")	1.0mm (0.039")	29mm (1.14")
6.0mm (1/4")	19mm (3/4")	1.25mm (0.049")	34mm (1.34")
6.0mm (1/4")	25mm (1")	1.25mm (0.049")	45mm (1.77")

Fluoroseal is suitable for cryogenic application, and for temperatures up to 260°C (500°F).

Typical applications:

Hydraulic systems, pneumatic systems, water supply systems, ventilation ducts, fan housing, fume ducts, engine case doors etc.

Bolt Forces per Unit Length of Seal

Width (in.)	Gas Tight (lbf/in.)		Water Tight (lbf/in.)
	Smooth Flanges	Rough Flanges	
1/8	500	-	280
3/16	1260	-	280
1/4	1260	2520	390
3/8	1540	2800	390
1/2	1540	2940	390
5/8	1680	2940	420
3/4	1960	3360	420

Gas tight is based on compressed air at 600 psi.
Water tight is based on water at 30 psi.

Fluoroseal Universal Joint Sealant Nominal Sizes

Width (in.)	Spool Length (ft.)
1/8	100
3/16	75
1/4	50
3/8	25
1/2	15
5/8	15
3/4	15
1	15

Flexitallic Flexicarb[®]

The Flexitallic Flexicarb range of sheet sealing materials is manufactured from high purity exfoliated graphite flake, and is available with or without a reinforcing metallic core. The “standard” product range is based upon graphite with a minimum carbon content of 98% and, for nuclear applications, graphite with a minimum carbon content of 99.85% is available. The graphite foils can be attached to the reinforcing core by mechanical means or by the use of selected adhesives.

Flexicarb laminates are particularly suited for applications involving moderately high temperatures and pressures in conjunction with a wide range of media. They are widely used in demanding general industrial applications and in the petrochemical/refining industries. Because these products do not contain any rubber or polymeric binders they have the highest levels of stress retention, ensuring that gasket stress applied during assembly is maintained during service.

Graphite based products are resistant to most industrial chemicals but are susceptible to attack by oxidizing agents such as nitric acid. Sulfuric acid can also attack graphite at certain combinations of concentration and temperature. When selecting a graphite laminate for use in chemical service, consideration must be given to any possible reaction between the chemical medium and the reinforcing metallic core.

In air or in services where oxygen is present, graphite can burn away at high temperatures as it is converted to oxides of carbon. The rate at which this occurs depends on the application temperature and the concentration of oxygen present. In a well bolted flange only the inner edge of the gasket will be exposed to oxygen in the pipe; the graphite will burn away very slowly with service life being dictated by the land width of the gasket. In high temperature applications where the fluid being sealed does not contain oxygen, consideration must be given to possible attack of the graphite by oxygen from the external atmosphere surrounding the flange.

For long term service, work by independent testing has shown that maximum service temperature should be much lower than that usually quoted in manufacturers’ literature. This work has been validated by the Tightness Testing Research Laboratory (TTRL) at Ecole Polytechnique in Montreal on behalf of the Pressure Vessel Research Council (PVRC). The TTRL report included the maximum service temperatures for various periods of service for graphite sheet gaskets as shown in the table:

Required Service Life Years	Maximum Service Temperature	
	°C	°F
1	370	691
3	330	630
5	320	610
10	305	580

Product Range

Flexicarb Laminated Sheet LS (GS 600)* - Homogeneous Graphite foil. This product is used for the production of graphite laminates.

Flexicarb SR (RGS4)* - This laminate contains a 0.05mm (0.002”) thick 316 stainless steel core with adhesively bonded graphite facing.

Flexicarb ST (RGS 3)* - This laminate contains a tanged 0.1mm (0.004”) thick 316 stainless steel core onto which the graphite faces are mechanically attached. This gasket is used where high pressures have to be contained and is particularly suitable for use in superheated steam service.

Flexicarb NR (RGS 1)* - Laminate in which the graphite is adhesively bonded onto a 13 micron (0.0005”) thick nickel core using a chemically resistant nitrile phenolic adhesive.

* Parenthesis UK designation

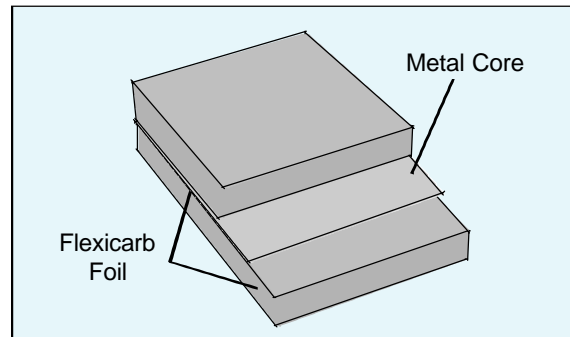

Compressed Non-asbestos Fiber Gaskets

Product Range

SF 1600 - A low cost mineral filled calendered sheet material, containing cellulose and glass fiber reinforcements. This material was developed to suit low pressure, non critical applications.

SF 2400 - A general purpose sheet material reinforced with aramid fibers and bound with nitrile rubber. SF 2400 complies with the British Standard for non-asbestos sheet sealing materials - BS 7531 Grade Y. Also available with a wire mesh reinforcement - SFM 2400. When specific polymeric binder types are required SF 2420 (SBR) and SF 2440 (polychloroprene) are also available; the latter is often preferred for sealing freons and other refrigerant media.

SF 3300 - A premium quality sheet material reinforced with a blend of aramid and glass fibers and bound with nitrile rubber. SF 3300 complies with the highest grade of the British Standard for non-asbestos sheet sealing materials - BS 7531 Grade X. For applications in split case pumps where a thin, complex gasket capable of withstanding a high surface stress is required, SF 3500, a variant of SF 3300, has been developed.

Where caustic liquors have to be sealed a variant of SF 3300 reinforced with a blend of aramid and carbon fibers is offered: this material, SF 5000 is widely used in the pulp and paper industry.

AF 2100 - A high temperature material reinforced with non-respirable glass fibers and bound with nitrile rubber. Because of its high compressibility, AF 2100 can be used most advantageously at lower thicknesses than the CAF which it replaces. Also available with a wire mesh reinforcement - AFM 2100.



Flexitallic Compressed Sheet Application Guide

Material	Composition	Applications	Relative Cost (1 = lowest)
SF1600	Glass/Cellulose/Natural Rubber	Non-critical service; hydrotest; economical sheet; max temp 110 - 177°C (230 to 350°F)	1
SF 2400	Aramid/NBR	Excellent high performance, general purpose sheet for steam, water, gases, oils, mild solvents and alkalis; max temp 177 - 400°C (350 to 750°F)	2
AF 2100	Glass/NBR	Steam, water, gases, oils, mild acids, alkalis, general chemicals; max temp 177 - 477°C (350 - 890°F)	3
AF 2150	Glass/NBR/Wire Gauze	Same as above, fluctuating pressure, vibrations	3
SF 2420	Aramid/SBR	Same as SF 2400 except SBR binder; ideal for the paper making industry; max temp 177 - 400°C (350 - 750°F)	4
SF 2440	Aramid/Chloroprene	Same as SF 2400 except Chloroprene binder; Refrigerants and where self-extinguishing properties are required; max temp 177 - 400°C (350 - 750°F)	5
SF 3300	Aramid/Glass/NBR	Top Grade sheet for general industrial applications; max temp 177 - 440°C (350 - 825°F)	6
SF 3500	Aramid/Glass/NBR	More aramid fiber than SF 3300 for increased strength in split casing pumps; max temp 440°C (825°F) @ 1/64" thk	7
SF 5000	Carbon/Aramid/NBR	Especially suitable for sealing caustic liquors; max temp 177 - 440°C (350 - 825°F)	8

Note: Maximum temperature based on material thickness.

Sheet Materials Chemical Compatibility Selector Guide

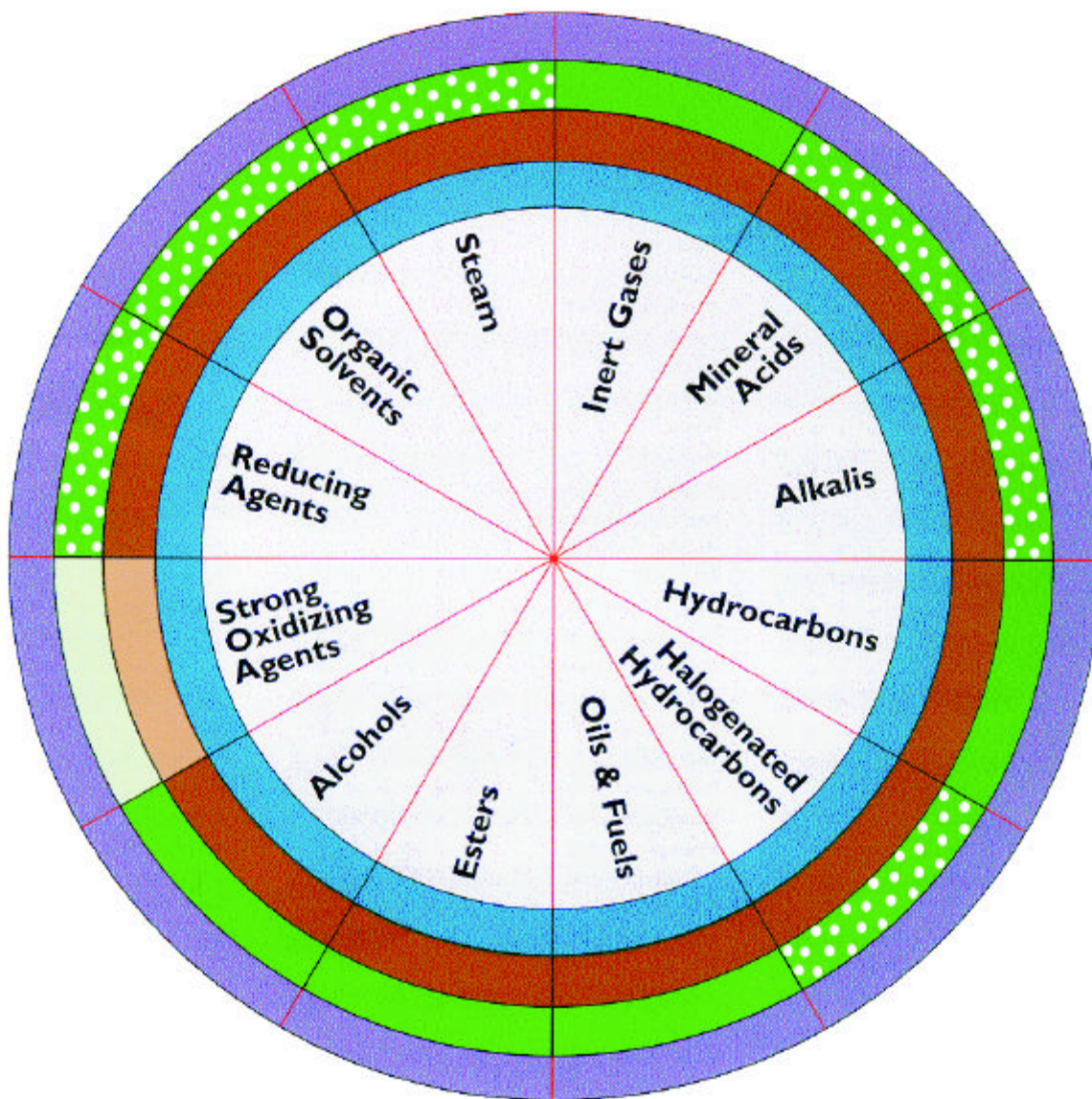

	Suitable	Application Dependent	Not Suitable
Sigma Range			
Flexicarb Range			
SF and AF Range			
Thermiculite			

Sheet Materials Chemical Compatibility Chart

	Sigma		Thermiculite		Flexicarb (FG)	SF2400 SF3300 SF3500	SF2420	SF2440	SF2500	SF5000	SF1600	AF2100
	500 511 577	522 533	815	816								
Acetic acid glacial	Y	Y	Y	Y	Y	Y	Y	Y	Y	Y	N	N
Acetone	Y	Y	Y	Y	Y	Y	Y	Y	Y	Y	N	Y
Acetylene	Y	Y	Y	Y	Y	Y	Y	Y	Y	Y	N	Y
Acrylic acid	Y	Y	Y	Y	Y	Y	Y	Y	Y	Y	N	N
Acrylonitrile	Y	Y	Y	O	Y	Y	O	Y	Y	Y	N	Y
Air	Y	Y	Y	Y	Y	Y	Y	Y	Y	Y	Y	Y
Alkaline lye	Y	Y	Y	Y	Y	O	O	O	Y	Y	N	O
Aluminum chloride	Y	Y	Y	Y	Y	O	O	O	Y	O	N	O
Ammonia gas	Y	Y	Y	Y	Y	Y	Y	Y	Y	Y	O	Y
Ammonia	Y	Y	Y	Y	Y	Y	Y	Y	Y	Y	N	Y
Amyl acetate	Y	Y	Y	O	Y	Y	O	Y	Y	Y	O	Y
Amyl alcohol	Y	Y	Y	O	Y	Y	O	Y	Y	Y	O	Y
Aniline	Y	Y	Y	Y	Y	N	N	N	N	N	N	O
Aqua-regia	Y	Y	Y	Y	N	N	N	N	N	N	N	N
Aviation fuel	Y	Y	Y	O	Y	Y	O	Y	Y	Y	O	Y
Beer	Y	Y	Y	Y	Y	Y	Y	Y	Y	Y	Y	Y
Benzene	Y	Y	Y	O	Y	Y	O	Y	Y	Y	O	Y
Benzoyl chloride	Y	Y	Y	O	Y	Y	O	Y	O	Y	N	Y
Biphenyl	Y	Y	Y	Y	Y	Y	Y	Y	Y	Y	N	Y
Blast furnace gas	Y	Y	Y	Y	Y	Y	Y	Y	Y	Y	N	Y
Bleach (solution)	Y	Y	Y	Y	Y	Y	Y	Y	Y	Y	O	Y
Boiler feed water	Y	Y	Y	Y	Y	Y	Y	Y	Y	Y	Y	Y
Brine	Y	Y	Y	Y	Y	Y	Y	Y	Y	Y	Y	Y
Bromine	Y	Y	N	N	O	N	N	N	N	N	N	N
n-butyl acetate	Y	Y	Y	O	Y	Y	O	Y	Y	Y	Y	Y
Calcium chlorate	Y	Y	Y	Y	Y	N	N	N	Y	Y	N	N
Capro-lactam	Y	Y	Y	O	Y	Y	O	Y	Y	Y	N	Y
Carbolic Acid	Y	Y	Y	Y	Y	N	N	N	Y	Y	N	N
Carbon dioxide	Y	Y	Y	Y	Y	Y	Y	Y	Y	Y	Y	Y
Carbon disulphide	Y	Y	Y	Y	Y	N	N	N	N	N	N	N
Carbon monoxide	Y	Y	Y	Y	Y	Y	Y	Y	Y	Y	Y	Y
Carbon tetrachloride	Y	Y	Y	O	Y	Y	O	N	Y	Y	N	Y
Chile saltpetre	Y	Y	Y	Y	Y	Y	Y	Y	Y	Y	Y	Y
Chlorine dry	Y	Y	Y	Y	Y	N	N	N	Y	N	N	N
Chlorine wet	Y	Y	Y	Y	Y	N	N	N	O	N	N	N
Chlorinated hydrocarbons	Y	Y	Y	O	Y	O	O	O	O	O	N	N
Chloroacetic acid	Y	Y	Y	Y	Y	O	O	O	Y	O	N	N
Chloro benzene	Y	Y	Y	O	Y	Y	O	O	O	Y	N	Y
Chromic acid	Y	Y	Y	Y	O	N	N	N	O	N	N	N
Copper sulphate	Y	Y	Y	Y	Y	Y	Y	Y	Y	Y	Y	Y
Creosote	Y	Y	Y	Y	Y	Y	O	Y	Y	Y	O	O
Cresol	Y	Y	Y	Y	Y	N	N	N	O	N	Y	N
Crude oil	Y	Y	Y	Y	Y	Y	Y	Y	Y	Y	O	Y
Cyclohexanol	Y	Y	Y	O	Y	Y	O	Y	Y	Y	Y	Y
1,4-Dichlorobenzene	Y	Y	Y	O	Y	O	N	N	N	O	N	O
Diesel Oil	Y	Y	Y	Y	Y	Y	Y	Y	Y	Y	O	Y
Dowtherm	Y	Y	Y	Y	Y	Y	Y	Y	Y	Y	N	Y
Dye Liquor	Y	Y	Y	Y	Y	O	O	O	Y	O	N	O
Ethyl acetate	Y	Y	Y	O	Y	Y	O	Y	O	Y	N	Y
Ethyl alcohol	Y	Y	Y	Y	Y	Y	Y	Y	Y	Y	Y	Y
Ethylene glycol	Y	Y	Y	Y	Y	Y	Y	Y	Y	Y	Y	Y
Ethylene oxide	Y	Y	Y	Y	Y	Y	O	Y	N	Y	N	Y
Ethyl ether	Y	Y	Y	O	Y	Y	O	Y	Y	Y	Y	Y
Ethylene	Y	Y	Y	Y	Y	Y	Y	Y	Y	Y	Y	Y
Ethylene chloride	Y	Y	Y	O	Y	N	N	N	Y	N	N	N
Fatty acids	Y	Y	Y	Y	Y	Y	Y	Y	Y	Y	Y	Y
Ferric chloride	Y	Y	Y	Y	O	Y	Y	Y	Y	Y	O	Y
Fluorine	N	N	N	N	Y	N	N	N	N	N	N	N
Fluorosilicic acid	Y	Y	N	N	Y	N	N	N	Y	N	N	N
Formaldehyde	Y	Y	Y	O	Y	Y	O	Y	Y	Y	O	Y
Formic acid 85%	Y	Y	Y	Y	Y	O	O	O	Y	O	N	N
Formic acid 10%	Y	Y	Y	Y	Y	Y	O	O	Y	Y	N	O
Freons	Y	Y	Y	Y	Y	O	O	O	N	O	N	O
Gas oil	Y	Y	Y	Y	Y	Y	Y	Y	Y	Y	N	Y
Gasoline	Y	Y	Y	Y	Y	Y	Y	Y	Y	Y	Y	Y
Heating oil	Y	Y	Y	Y	Y	Y	Y	Y	Y	Y	Y	Y
Hydraulic oil (glycol)	Y	Y	Y	Y	Y	Y	Y	Y	Y	Y	Y	Y
Hydraulic oil (mineral)	Y	Y	Y	Y	Y	Y	Y	Y	Y	Y	Y	Y
Hydraulic oil (phosphate ester)	Y	Y	Y	Y	Y	Y	O	Y	Y	O	O	Y
Hydrazine	Y	Y	Y	Y	Y	Y	Y	Y	Y	Y	N	Y
Hydrocarbons (aromatic)	Y	Y	Y	O	Y	Y	O	Y	Y	Y	N	Y
Hydrocarbons aliphatic (sat.)	Y	Y	Y	Y	Y	Y	Y	Y	Y	Y	O	Y
Hydrocarbons aliphatic (unsat.)	Y	Y	Y	O	Y	Y	O	Y	Y	Y	O	Y
Hydrochloric acid (37% HCl)	Y	Y	Y	Y	Y	N	N	N	Y	N	N	N
Hydrofluoric acid	N	O	N	N	Y	N	N	N	O	N	N	N
Hydrogen	Y	Y	Y	Y	Y	Y	Y	Y	Y	Y	O	Y
Hydrogen chloride	Y	Y	Y	Y	Y	N	N	N	Y	N	N	N
Hydrogen fluoride	N	O	N	N	Y	N	N	N	O	N	N	N
Hydrogen peroxide	Y	Y	Y	Y	O	N	N	N	O	N	N	N

LEGEND:
 Y = Suitable for Application
 O = Suitability Depends On Operating Conditions
 N = Not Suitable

Sheet Materials Chemical Compatibility Chart

	Sigma		Thermiculite		Flexicarb (FG)	SF2400 SF3300 SF3500	SF2420	SF2440	SF2500	SF5000	SF1600	AF2100
	500 511 577	522 533	815	816								
Hydrogen sulfide	Y	Y	Y	Y	Y	Y	Y	Y	Y	Y	O	Y
Isopropyl acetate	Y	Y	Y	O	Y	Y	O	Y	Y	Y	Y	Y
Isopropyl alcohol	Y	Y	Y	Y	Y	Y	Y	Y	Y	Y	Y	Y
Kerosene	Y	Y	Y	Y	Y	Y	Y	Y	Y	Y	Y	Y
Lime	Y	Y	Y	Y	Y	Y	Y	Y	Y	Y	Y	Y
Lubrication oil	Y	Y	Y	Y	Y	Y	Y	Y	Y	Y	O	Y
Machine oil	Y	Y	Y	Y	Y	Y	Y	Y	Y	Y	O	Y
Magnesium sulphate	Y	Y	Y	Y	Y	Y	Y	Y	Y	Y	Y	Y
Malic acid	Y	Y	Y	Y	Y	Y	Y	Y	Y	Y	O	O
Methane	Y	Y	Y	Y	Y	Y	Y	Y	Y	Y	Y	Y
Methyl acrylate	Y	Y	Y	O	Y	Y	O	Y	O	Y	O	Y
Methyl alcohol	Y	Y	Y	Y	Y	Y	Y	Y	Y	Y	Y	Y
Methyl isobutyl ketone	Y	Y	Y	O	Y	O	O	O	O	O	N	O
Methyl methacrylate	Y	Y	Y	Y	Y	Y	O	Y	O	Y	N	Y
Methylene chloride	Y	Y	Y	O	Y	N	N	N	O	N	N	N
Mineral oil	Y	Y	Y	Y	Y	Y	Y	Y	Y	Y	O	Y
Mobiltherm	Y	Y	Y	Y	Y	Y	Y	Y	Y	Y	O	Y
Naphthalene	Y	Y	Y	Y	Y	Y	Y	Y	Y	Y	O	Y
Natural gas	Y	Y	Y	Y	Y	Y	Y	Y	Y	Y	Y	Y
Nitric acid (concentrated 50%)	Y	Y	Y	Y	O	N	N	N	Y	N	N	N
Nitric acid (fuming 95%)	Y	Y	Y	Y	N	N	N	N	N	N	N	N
Nitrogen	Y	Y	Y	Y	Y	Y	Y	Y	Y	Y	Y	Y
Oleum	Y	N	O	O	N	N	N	N	N	N	N	N
Oxygen	Y	Y	Y	Y	O	Y	Y	Y	Y	Y	O	Y
Paraffin	Y	Y	Y	Y	Y	Y	Y	Y	Y	Y	Y	Y
Pentachlorophenol	Y	Y	Y	Y	Y	N	N	N	N	N	N	N
Perchloric acid	Y	Y	N	N	N	N	N	N	N	N	N	N
Petroleum	Y	Y	Y	Y	Y	Y	Y	Y	Y	Y	Y	Y
Phenol	Y	Y	Y	Y	Y	N	N	N	O	N	N	N
Phosgene	Y	Y	N	N	Y	N	N	N	N	N	N	N
Phosphoric acid (concentrated)	O	Y	Y	Y	Y	N	N	N	N	N	N	N
Phosphoric acid (dilute)	Y	Y	Y	Y	Y	Y	Y	Y	Y	Y	Y	Y
Phosphorous	Y	Y	N	N	O	N	N	N	N	N	N	N
Phthalic anhydride	Y	Y	Y	Y	Y	N	N	N	O	N	N	N
Potassium hydroxide	O	Y	Y	Y	Y	O	O	O	Y	Y	N	O
Potassium nitrate	Y	Y	Y	Y	Y	Y	Y	Y	Y	Y	Y	Y
Potassium permanganate	Y	Y	Y	Y	Y	Y	Y	Y	Y	Y	Y	Y
Producer gas	Y	Y	Y	Y	Y	Y	Y	Y	Y	Y	Y	Y
Pyridine	Y	Y	Y	Y	Y	N	N	N	N	N	N	N
Sea water	Y	Y	Y	Y	Y	Y	Y	Y	Y	Y	Y	Y
Silicone oil	Y	Y	Y	Y	Y	Y	Y	Y	Y	Y	Y	Y
Soda ash	Y	Y	Y	Y	Y	Y	Y	Y	Y	Y	Y	Y
Sodium bi-carbonate	Y	Y	Y	Y	Y	Y	Y	Y	Y	Y	Y	Y
Sodium carbonate	Y	Y	Y	Y	Y	Y	Y	Y	Y	Y	Y	Y
Sodium cyanide	Y	Y	Y	Y	Y	Y	Y	Y	Y	Y	Y	Y
Sodium hydroxide (40%)	N	Y	Y	Y	Y	N	N	N	Y	Y	N	N
Sodium hydroxide (dilute)	Y	Y	Y	Y	Y	Y	Y	Y	Y	Y	N	Y
Sodium hypochlorite	Y	Y	Y	Y	Y	Y	Y	Y	Y	Y	O	Y
Sodium nitrate	Y	Y	Y	Y	Y	Y	Y	Y	Y	Y	Y	Y
Starch	Y	Y	Y	Y	Y	Y	Y	Y	Y	Y	Y	Y
Steam	Y	Y	Y	Y	Y	Y	Y	Y	Y	Y	O	Y
Steam condensate	Y	Y	Y	Y	Y	Y	Y	Y	Y	Y	Y	Y
Styrene	Y	Y	Y	Y	Y	O	O	O	N	O	N	O
Sulphur	Y	Y	Y	Y	Y	Y	Y	Y	Y	Y	O	Y
Sulphur dioxide	Y	Y	Y	Y	Y	Y	Y	Y	Y	Y	Y	Y
Sulphur trioxide	Y	Y	Y	Y	N	N	N	N	Y	N	N	N
Sulphuric acid (concentrated)	Y	O	Y	Y	N	N	N	N	Y	N	N	N
Sulphuric acid (fuming)	Y	N	O	O	N	N	N	N	N	N	N	N
Tar	Y	Y	Y	Y	Y	Y	Y	Y	Y	Y	Y	Y
Turpentine	Y	Y	Y	Y	Y	Y	Y	Y	Y	Y	Y	Y
Toluene	Y	Y	Y	O	Y	Y	O	Y	Y	Y	N	Y
Towns gas	Y	Y	Y	Y	Y	Y	Y	Y	Y	Y	Y	Y
Transformer oil	Y	Y	Y	Y	Y	Y	Y	Y	Y	Y	O	Y
Tributyl phosphate	Y	Y	Y	Y	Y	Y	Y	Y	Y	Y	Y	Y
Triethanolamine	Y	Y	Y	Y	Y	Y	Y	Y	Y	Y	Y	Y
Urea	Y	Y	Y	Y	Y	Y	Y	Y	Y	Y	Y	Y
Vegetable Oil	Y	Y	Y	Y	Y	Y	Y	Y	Y	Y	Y	Y
Vinyl acetate	Y	Y	Y	O	Y	Y	O	Y	Y	Y	O	Y
Vinyl chloride	Y	Y	Y	O	Y	Y	O	Y	Y	Y	O	Y
Vinylidene chloride	Y	Y	Y	O	Y	Y	O	Y	Y	Y	O	Y
Water	Y	Y	Y	Y	Y	Y	Y	Y	Y	Y	Y	Y
Water condensate	Y	Y	Y	Y	Y	Y	Y	Y	Y	Y	Y	Y
Water distilled	Y	Y	Y	Y	Y	Y	Y	Y	Y	Y	Y	Y
Whisky	Y	Y	Y	Y	Y	Y	Y	Y	Y	Y	Y	Y
Wine	Y	Y	Y	Y	Y	Y	Y	Y	Y	Y	Y	Y
White Spirit	Y	Y	Y	Y	Y	Y	Y	Y	Y	Y	O	Y
Xylene	Y	Y	Y	O	Y	Y	O	Y	Y	Y	N	Y

LEGEND:
 Y = Suitable for Application
 O = Suitability Depends On Operating Conditions
 N = Not Suitable

Insulating Sets

Insulating sets comprise of a phenolic laminate or neoprene faced phenolic laminate gasket (Style NCA and NCB only) which is located between the flange sealing faces, phenolic laminate bolt sleeves, two insulating washers per bolt for maximum protection and two plated mild steel washers per bolt. Stainless steel washers can be supplied upon request.

Insulating sets are essentially used for pipeline flange corrosion protection, where a seal is required between dissimilar flange materials. The use of dissimilar metallic flanges with a conductive gasket material accompanied with a suitable electrolyte may set up a galvanic cell which will corrode the anodic metal. Insulating sets are also used to electrically isolate flange joints, preventing the flow of electrostatic charge along pipelines.

There are three standard styles of insulating sets available to suit raised face, flat face, and ring grooved flanges, as illustrated below.

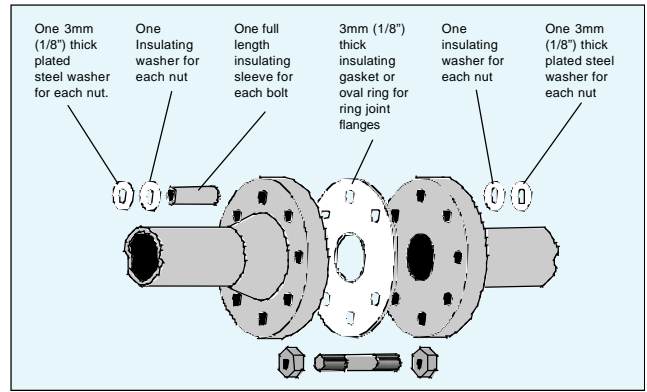

Standard Styles

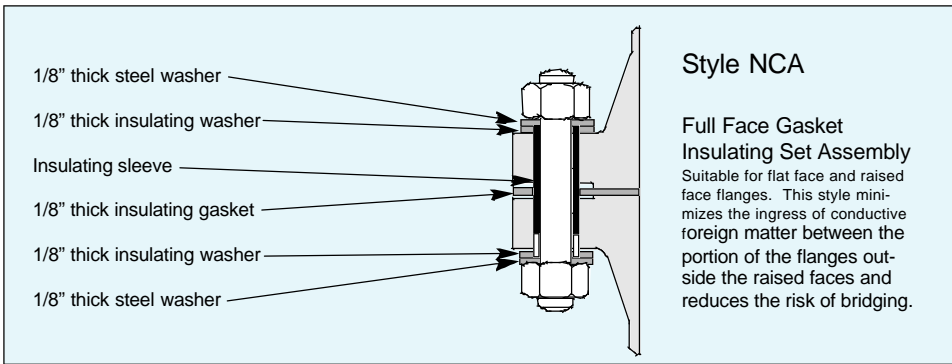

It is also recommended that for complete electrical insulation protection that self-adhesive tape is wrapped around the outside diameter of the flange to prevent the ingress of foreign matter.

With style NCA and NCB insulating sets it is imperative that the bore of the gasket is equal to that of the pipe. This will prevent any foreign matter from accumulating in the annular space between the bore of the gasket and the bore of the pipe thus preventing bridging.

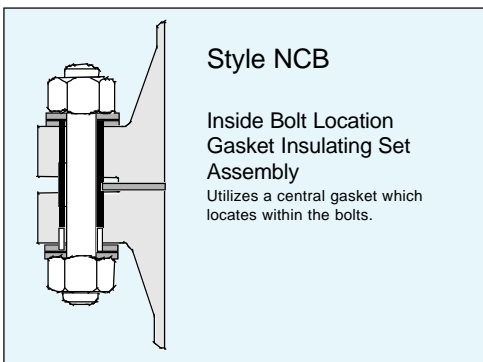

Phenolic laminate provides excellent insulating properties as well as corrosion resistance. See table for typical properties of 3mm (1/8") thick phenolic. Other gasket styles such as Sigma and non-asbestos sheets may also be suitable.

Typical Properties of Phenolic Gaskets	
Maximum axial compressive stress	315MPa (45,700 psi)
Axial electric strength in oil @ 90°C (190°F)	23kV/cm (58kV/in)
Maximum operating temperature	120°C (250°F)
Minimum operating temperature	-60°C (-76°F)

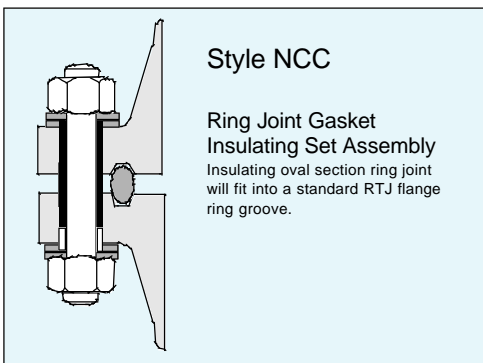

As standard, Flexitallic insulating kits are dimensioned to suit schedule 80 pipe suitable for use on standard and non-standard flange assemblies up to and inclusive of Class 2500.

TYPICAL APPLICATIONS

Offshore installations, sea water environments, hydrocarbon service, chemical installations, oil refining pipelines requiring galvanic corrosion protection and electrical insulation.

Metal Jacketed Gaskets

Metal Jacketed Gaskets, as the name suggests, consist of a metallic outer shell with either a metallic or non-metallic asbestos-free filler. The filler material gives the gasket resilience, while the metal jacket protects the filler and resists pressures, temperatures and corrosion.

A wide range of materials are available to suit specific temperature and corrosive conditions.

<i>Metallic:</i>	Soft Iron	Nickel	<i>Non-Metallic:</i>	Non-asbestos Millboard
	Carbon Steel	Aluminum		PTFE
	Stainless Steel	Brass		Flexicarb®
	Inconel®	Copper		Ceramic
	Monel®	(Other materials on request)		

Metal Jacketed Gaskets are available in a wide range of sizes and configurations. They are traditionally used for heat exchanger applications, pumps, and valves, however the resilience and recovery properties of these gaskets are limited. Metal Jacketed Gaskets require smooth flange surface finishes, high bolt loads, and flange flatness in order to seal effectively.

When pass partition bars are required, it is sufficient to use a gasket with a welded pass bar construction, as opposed to an integral pass bar construction. Jacketed gaskets standard tolerances:

<i>Jacketed Gaskets Standard Tolerances</i>		
<i>Gasket Outer Diameter</i>	<i>I.D.</i>	<i>O.D.</i>
Up to 6"	+1/32" / -0	+0 / -1/32"
6" to 60"	+1/16" / -0	+0 / -1/16"
Above 60"	+3/32" / -0	+0 / -3/32"

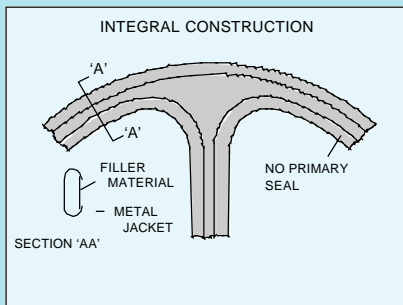

If leakage occurs across the pass partition bar, the fluid will flow along the length of the pass bar arrangements, and then flow to the outer diameter of the gasket being retained only by the secondary seal. The intermediate part of the gasket does very little to effect the sealing capabilities of the gasket.

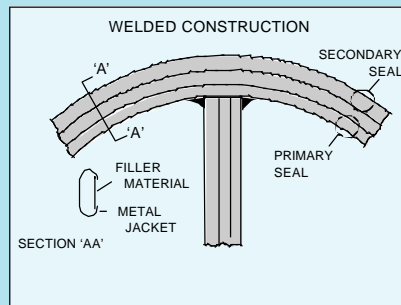

With a welded pass bar arrangement the fluid is retained by the primary seal at the inner diameter of the gasket. Thus the primary seal maintains its function, providing a seal of higher integrity.

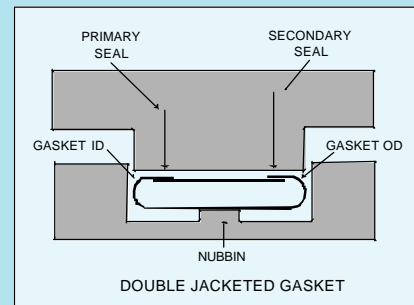

Due to the high bolt loads required to seat metal jacketed gaskets, designers often incorporate stress raising nubbins on the flange sealing face, the principle being that the majority of the applied bolt load is acting on a relatively small proportion of the gasket surface area, thus high surface stresses result. It is essential that the gasket is installed with the smooth side toward the nubbins.

Metal Jacketed Gaskets

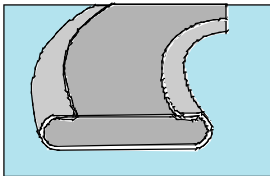

Style 123

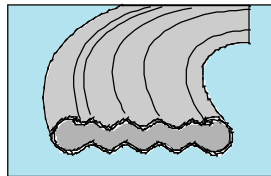

Style 126

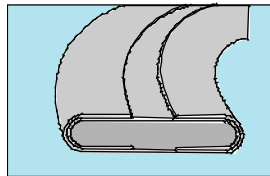

Style 127

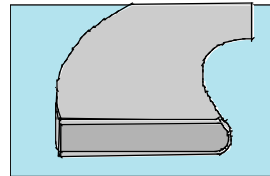

Style 130

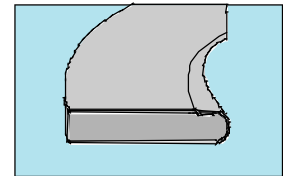

Style 131

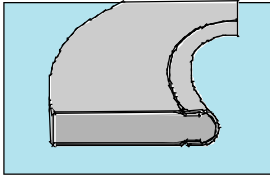

Style 132

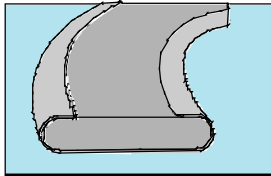

Style 120

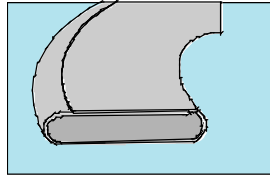

Style 124

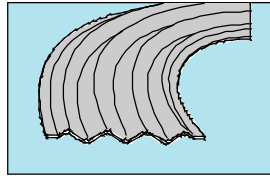

Style 100

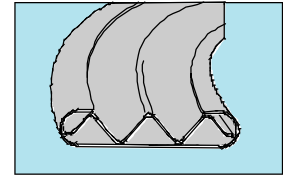

Style 102

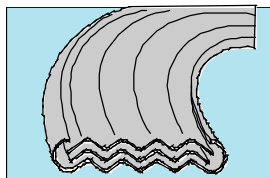

Style 129

DOUBLE JACKETED GASKETS (Styles 123, 126, 127)

The filler material is completely enclosed by a two piece metal jacket, which covers both the inside and outside diameters and both contact surfaces. Style 126 is similar to Style 123 with the exception that the metal jacket is formed from a corrugated jacket providing better resilience than the Style 123, since the corrugations form multi-seals across the flange sealing face. Style 127 is a double shell gasket constructed of two reversed wrap-around shells. This provides handleability and better resistance to high pressures.

Double Jacketed Gaskets are used on boiler and heat exchanger applications when ample bolting is available to correctly seat the gasket. They are designed for high pressure and temperature applications up to and inclusive of Class 900. The temperature limitation of the gasket is dictated by the combination of metallic and non-metallic materials used in its construction. Gasket widths as narrow as 8mm (5/16") can be manufactured dependent on diameter. Very large gasket diameters can also be produced. Nominal gasket thickness is 3.2mm (1/8"). Gaskets can be manufactured with either integral or welded pass partition bars, in a variety of complex configurations. Some of the most common pass bar configurations are shown on page 20.

FRENCH-TYPE GASKETS (Styles 130, 131, 132)

The filler material is enclosed in a metal jacket, which covers the inside diameter of the gasket and completely covers the sealing faces on both sides. Available in three styles which are ideal for both small and large diameters in narrow as well as wide flange widths and in both circular and non-circular configurations. Typical applications include vacuum seals and valve bonnet seals of low pressure. Minimum gasket width 6.4mm (1/4"). Nominal gasket thickness 3.2mm (1/8").

SINGLE JACKETED GASKETS (Styles 120, 124)



The filler material is enclosed in a metal jacket which covers the inside and outside diameter of the gasket. Style 120 has one of its contact surfaces covered and is ideally suited for comparatively narrow flange widths in circular and non-circular configurations. Style 124 is an overlapped Single Jacketed Gasket, where the filler is completely enclosed on the inside and outside diameters and on both contact surfaces. Style 124 is more suited for high temperature applications of narrow gasket widths. Typical low pressure applications include boilers, compressors, pumps, and diesel and gasoline engines. Style 120 is not recommended for standard pipe flanges. Minimum flange width 6.4mm (1/4"). Nominal gasket thickness 3.2mm (1/8").

SOLID CORRUGATED METAL GASKETS (Styles 100, 102, 129)

As the name suggests, the solid corrugated metal gasket is comprised solely of metal and does not contain any non-metallic fillers in its construction. The temperature limitation of the gasket is therefore only affected by the metal selected. The corrugations provide multi-seals across the face of the gasket. A minimum of three corrugations is recommended and gasket thickness is approximately 50% of the corrugation pitch. Pitch corrugations can be 3.2mm (1/8"), 4.8mm (3/16") or 6.4mm (1/4"). Typically used for high temperature applications and applications involving steam, water, gas, oil, etc. up to 1000 psi for Style 129 and 102, and up to 500 psi for Style 100.

Metal Jacketed Gaskets

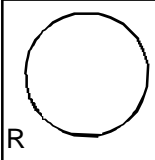
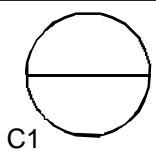
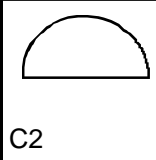
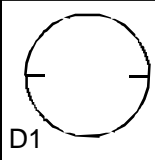
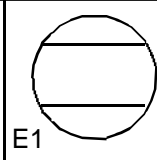
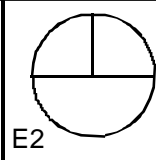
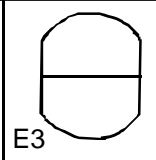
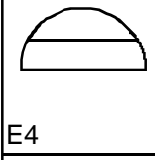
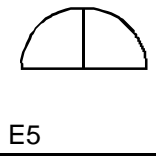
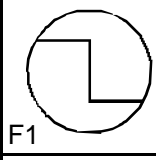
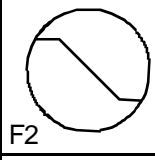
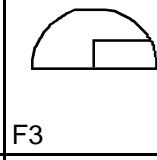
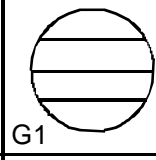
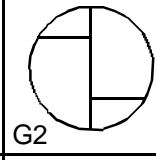
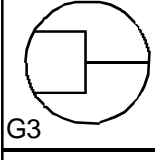
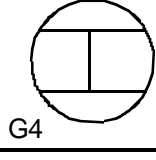
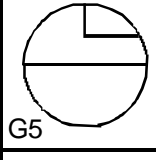
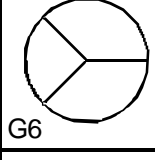
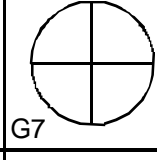
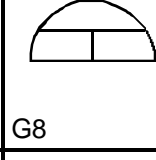
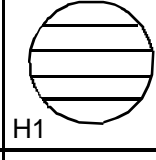
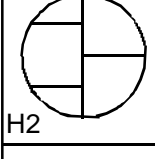
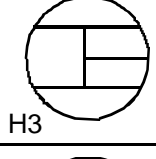
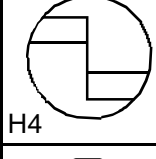
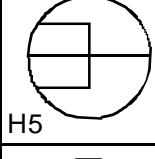
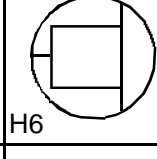
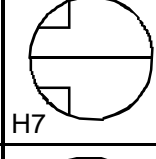
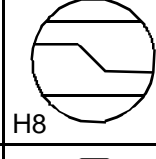
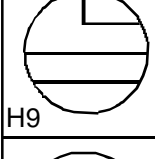
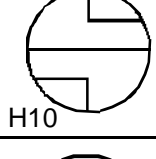
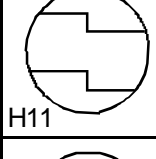
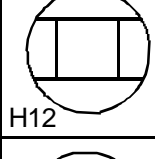
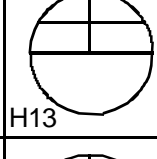
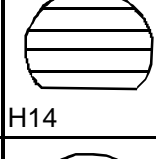
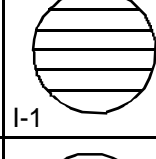
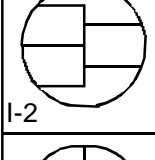
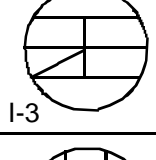
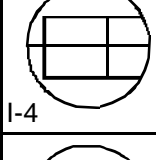
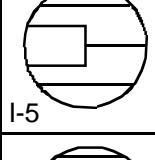
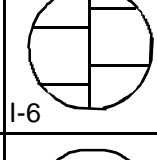
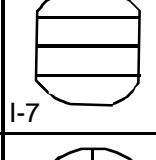
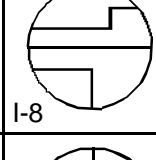
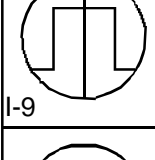
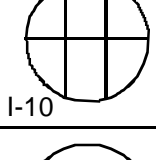
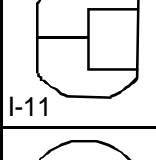
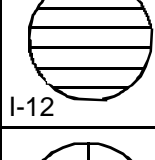
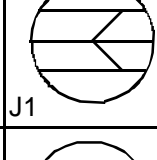
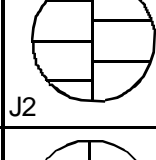
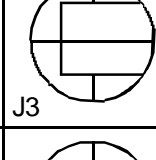
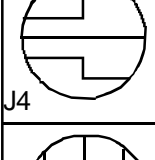
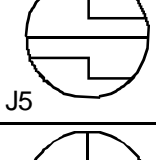
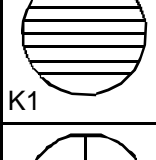
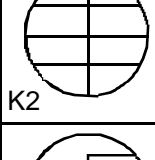
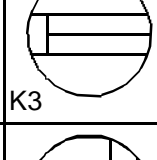
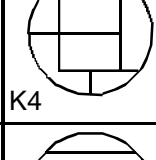
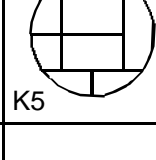
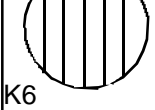
Schedule of Standard Shapes for Heat Exchanger Gaskets

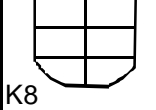
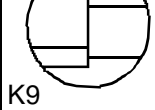
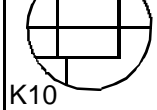
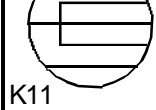
 R	 C1	 C2	 D1	 E1	 E2	 E3
 E4	 E5	 F1	 F2	 F3	 G1	 G2
 G3	 G4	 G5	 G6	 G7	 G8	 H1
 H2	 H3	 H4	 H5	 H6	 H7	 H8
 H9	 H10	 H11	 H12	 H13	 H14	 I-1
 I-2	 I-3	 I-4	 I-5	 I-6	 I-7	 I-8
 I-9	 I-10	 I-11	 I-12	 J1	 J2	 J3
 J4	 J5	 K1	 K2	 K3	 K4	 K5
 K6	 K7	 K8	 K9	 K10	 K11	

Other bar configurations available on request.

Spiral Wound Gaskets

A requirement of any gasket is the ability to recover under variable loads. The effects of pressure and temperature fluctuations, the temperature difference across the flange face, along with flange rotation, bolt stress relaxation and creep, demand a gasket with adequate flexibility and recovery, to maintain a seal under variable working conditions. The spiral wound gasket, invented by Flexitallic, meets these requirements.

A spiral wound gasket is manufactured by spirally winding a preformed metal strip and a filler on the outer periphery of metal winding mandrels. The winding mandrel outside diameter forms the inner diameter of the gasket and the superposed metal and non-metallic windings are continually wound until the required outer diameter is attained. Normal practice is to reinforce the inner and outer diameters with several plies of metal with no soft fillers. This engineered product is "tailor made" to be compatible with the flange closure in which it is to be used. For example, a closure designed for vacuum service may require a gasket of exactly the same dimensions as a closure designed for 1500 psi service. The closure designed for the vacuum service would have relatively light bolting indicating the necessity for a soft gasket, while the 1500 psi application would have heavy bolting requiring a relatively dense gasket. It is usually within our capability to satisfy both requirements.

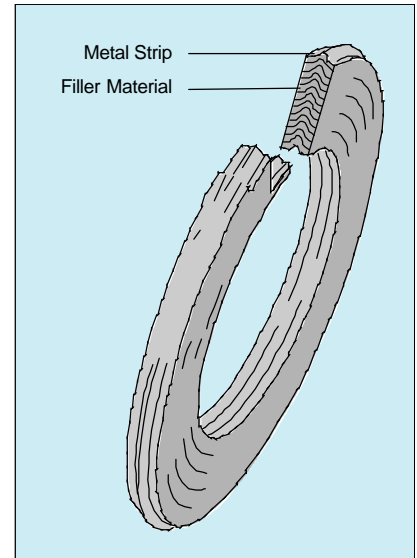
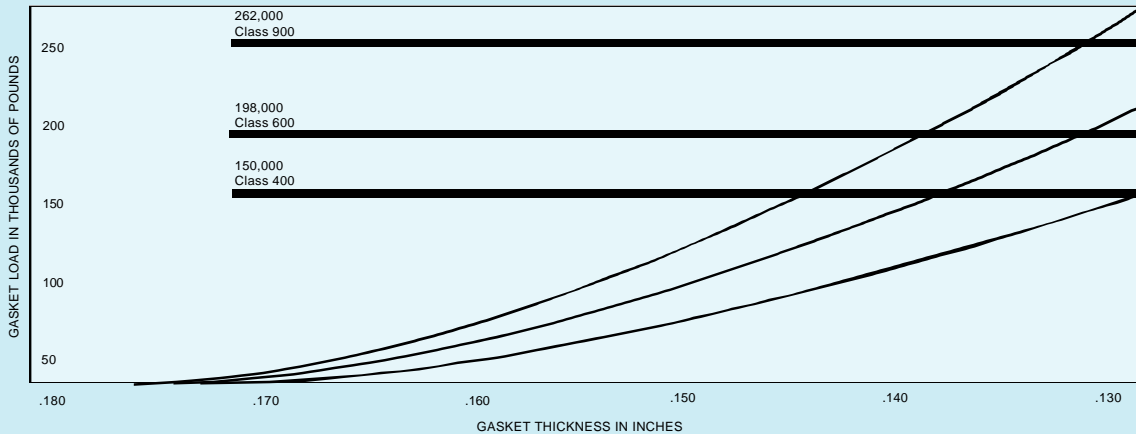

CHART NO. 1 GASKET COMPRESSION CHARACTERISTICS

6" Style CG Gasket
Contact Area: 14.7 Square Inches
Original Gasket Thickness 0.175"

This chart shows compression to 0.130" under stud stress of 30,000 psi of root area



GASKET DENSITY

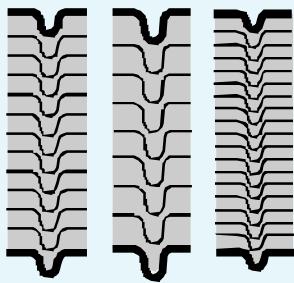

The service conditions under which a FLEXITALLIC spiral wound gasket is expected to hold its seal dictate the density of the gasket. Gaskets that have identical inside and outside diameters can be either hard or soft as shown on the left. The available compressive force is the basis for calculating the density of the gasket structure to support specific loads.

Spiral Wound Gaskets

STYLE R

Basic construction, inner and outer diameters are reinforced with several plies of metal without filler to give greater stability and better compression characteristics. Suitable for tongue and groove or male and female or groove to flat face flange assemblies.

STYLE RIR

Solid inner metal ring acts as a compression stop and fills the annular space between flange bore and the inside diameter of the gasket. Designed to prevent accumulation of solids, reduce turbulent flow of process fluids and minimize erosion of flange faces. Suitable for male and female pipe flanges.

STYLE CG

Utilizes an external ring which accurately centers gasket on flange face; provides additional radial strength to prevent gasket blowout and acts as a compression stop. A general purpose gasket suitable for use with flat face and raised face flanges.

STYLE CGI

Suitable for use with flat face and raised face flanges and specified for high pressure/temperature service or where corrosive or toxic media are present.

Note on use of inner rings: ASME B16.20, which covers spiral wound gaskets, requires the use of solid metal inner rings in:

- Pressure Class 900, nominal pipe sizes 24" and larger
- Pressure Class 1500, nominal pipe sizes 12" and larger
- Pressure Class 2500, nominal pipe sizes 4" and larger
- All PTFE filled gaskets.

ASME B16.20 recommends the use of inner rings if the user's experience has shown inward buckling of the gasket.

Flexitallic also recommends the use of inner rings for the following applications:

- Vacuum service or suction side of rotary equipment such as pumps and compressors
- Aggressive media, high pressure or temperature
- Surface finishes smoother than 125 micro-inch
- If over compression of the gasket is a concern.

It is customary to select inner ring material to be the same as the metal winding.

MULTI-CLASS

One gasket accommodates both Class 150 and 300 flanges. Multi-Class Gasket features are as follows:

- One gasket accommodates both Class 150 and 300 flanges, available pipe size 1/2" - 24" (Class 150 to 600 in NPS 1/2 through NPS 3)
- Low Stress (Style LS) gasket for Class 150 and 300 Flanges
- Reduces inventory requirements
- Easy to install . . . Less than half the studs need to be removed to change the gasket.

STYLE HE

Style HE gaskets are used for heat exchangers where pass bars may be required. The outer portion is of standard spiral wound construction, whereas the rib partition is normally of single or double jacketed style, securely fastened to the I.D. of the spiral wound portion.

STYLE HE-CG

This style is identical to the Style HE, except that it is fitted with an outer guide ring. Note: Style HE and Style HE-CG gaskets have a primary seal of spiral wound construction with its inherent resiliency and excellent sealing quality. It is necessary that dimensional drawings locating the pass ribs and the configurations be submitted for all inquiries and orders for these style gaskets.

Style R

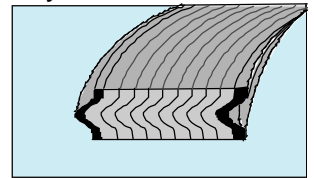

Style RIR

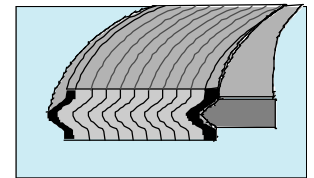

Style CG

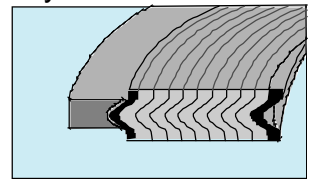

Style CGI

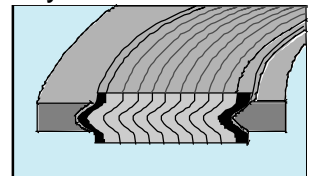

Multi-Class

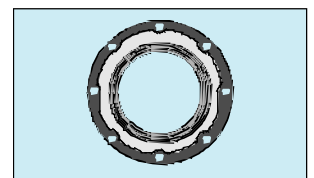

Style HE

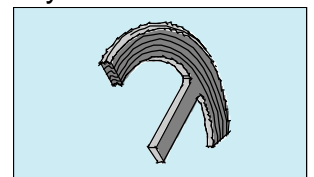

Style HE-CG

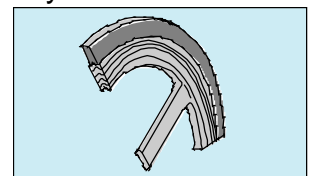

Spiral Wound Gaskets

STYLE HE-CGI WITH SPIRAL WOUND OUTER RING

The Style HE-CGI is a variation of the style CGI spiral wound gasket, developed for use on heat exchanger, TEMA type flange arrangements. In conjunction with an inner ring, the standard spiral wound construction also supports an outer wound steel nose, designed for the purpose of accurate gasket location. It is also available with a solid metal outer ring.

Style HE-CGI

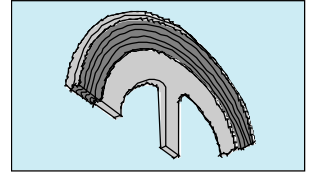

STYLE CG-RJ

This style designates a specially sized CG gasket to be used on standard ring joint flanges. The outer ring is dimensioned to cover the ring joint grooves and to prevent the spiral wound portion from entering the groove. This type of gasket should be used only as a maintenance repair item.

Style CG-RJ

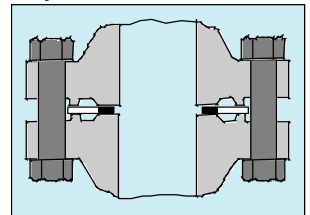

CARRIER RING

The carrier ring gasket consists of two spiral wound gaskets placed in a specially machined metallic ring as illustrated. The major advantages of the carrier ring are its high recovery, and ease of handling compared to standard spirals, due to its integral construction.

Carrier Ring

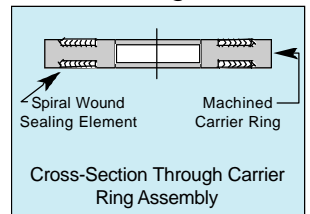

STYLE 625

Style 625 spiral wound gaskets are similar to Style R gaskets, with a thickness of 0.0625". These gaskets are widely used wherever space restrictions indicate the need for a wafer thin gasket design capable of sealing high pressures.

Style 625

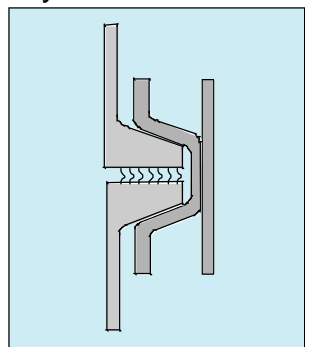

STYLE T

These gaskets are used for boiler handhole and tube cap assemblies. They are available in round, oval, obround, square, pear and diamond shapes. Refer to our general catalogue for standard Style T gaskets. Please note Style T gaskets rely on internal pressure in the boiler to properly seat the gasket. This means, when a hydrostatic test is performed on the gasket, the pressure exerted against the plate will further compress the gasket - and it is necessary to tighten each nut to compensate for the additional compression of the gasket under load.

Style T

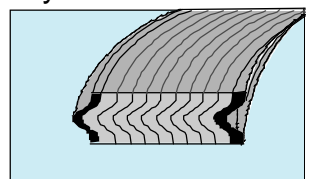

STYLE M, MC & MCS

These styles are designed for boiler manhole cover assemblies. They are usually of round, obround or oval shape, depending of course, upon the manhole plate configuration. Style MC gaskets have pre-formed inner and/or outer rings made of spiral windings. This centering guide permits the gasket to assume its correct position and to compensate for inequalities in plate contours and fillets in cold-pressed plates as well as to prevent shouldering and pinching caused by radial misplacement. Style MCS gaskets are manufactured with a solid metal inner and/or outer ring which also prevents over compression of the gasket in high pressure systems.

Style M

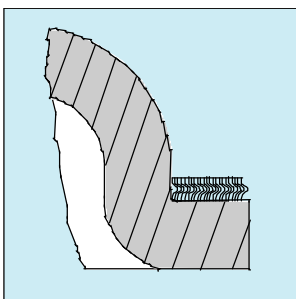

Style MC

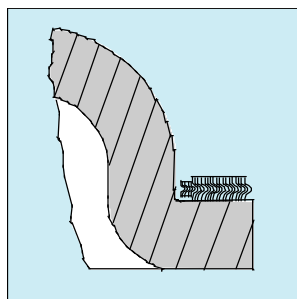

Style MCS

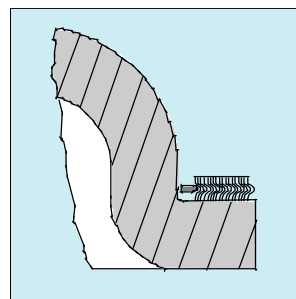

FLEXITALLIC Style LS^o Spiral Wound Gaskets The Alternative To Sheet Gaskets

Style LS^o & LSI^o

The Style LS spiral wound gasket has been engineered by FLEXITALLIC to provide an alternative to sheet gaskets in Class 150 and Class 300 service. Style LS gaskets have the inherent strength, resiliency and blowout resistance of spiral wound gaskets, yet require low bolt load for seating. They are manufactured with high purity flexible graphite, PTFE, or Thermiculite filler for optimum sealability, and are available for the full range of standard Class 150 and Class 300 flanges, as well as other non-standard low pressure flanges. PATENT NUMBERS 5161807 and 5275423.

The gasket allows designers to strictly adhere to ASME B and PV and ASME B31.3 codes requiring that bolt stresses do not exceed 25,000 psi. Where ASME flange design calculations indicate that flanges will be over stressed if a standard Class 150 spiral wound gasket is used, the LS gasket is designed to compress at significantly lower bolt load than standard Class 150 spiral wound gaskets, thereby maintaining flange stresses within allowable limits.

Style LS

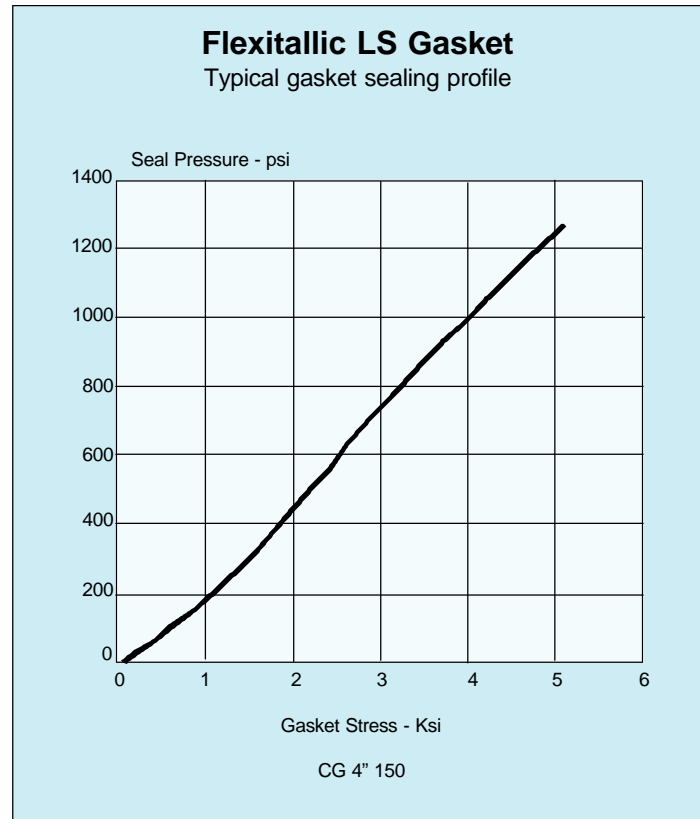
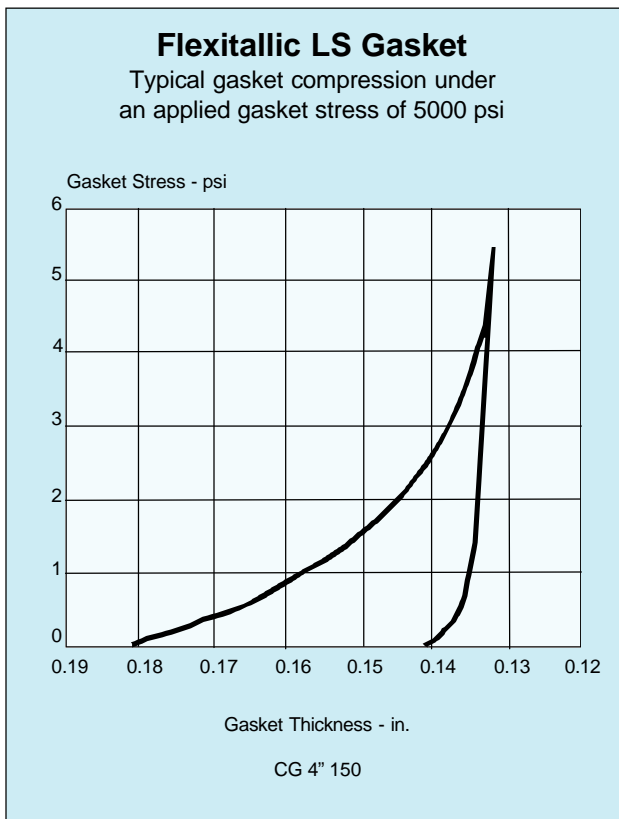
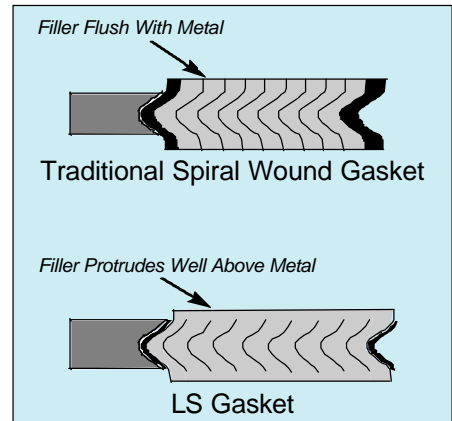

Spiral Wound Gaskets

FILLER MATERIALS

FLEXICARB®

A high purity flexible graphite with no binders or fillers. It exhibits superior sealability, and excellent resistance to a wide range of chemicals. Its unique combination of low permeability, inherent lubricity, and compressibility make FLEXICARB suitable for critical gas and vacuum service. Leachable chloride content of industrial grade FLEXICARB is 100 ppm maximum. Available in industrial, nuclear or corrosion inhibitor grades.

FLEXITE® SUPER

Low chloride filler material, developed by FLEXITALLIC, consisting of a Chlorite mineral with graphite and acrylic binder. This material may be used for general service applications.

THERMICULITE™

Filler material for use in applications with temperatures as high as 1600°F where graphite material is susceptible to oxidation. Thermiculite's sealability is by far superior to mica or ceramic. Wide range of chemical compatibility of Thermiculite makes it suitable for harsh applications such as nitric acid and high temperature NO_x gases.

POLYTETRAFLUOROETHYLENE (PTFE)

PTFE is used as a filler material in Flexitallic gaskets where extreme chemical inertness is required. PTFE is unaffected by any known chemicals except molten alkali metals and fluorine precursors. Because of its low permeability, PTFE is also frequently used as a filler material on FLEXITALLIC gaskets in vacuum applications. Gaskets wound with PTFE should be fully confined either by fitting in a groove or providing both an external and internal ring.

CERAMIC FIBER

Consists of aluminum silicate fiber with an organic binder. This material has a lower sealability compared to other filler materials, however, it has excellent high temperature stability to 1250°C (2300°F). It resists attack from most corrosive agents (except hydrofluoric and phosphoric acids) as well as concentrated alkalis. Recommended only where conditions preclude the use of Thermiculite filler.

Filler Material	Temperature Limits
Flexicarb	-400°F to 900°F
Thermiculite	-300°F to 1600°F
Flexite Super	-150°F to 572°F*
PTFE	-300°F to 500°F
Ceramic	-150°F to 2300°F

* Although Flexite Super has successfully been used at elevated temperatures we recommend that you consult our engineering department for specific applications.

Spiral Wound Gaskets

GASKET IDENTIFICATION GUIDE RING COLOR CODING

COLOR CODING FOR THE GASKETS YOU NEED. Gaskets are color coded to help expedite the selection and identity of the gaskets you need. The color on the outside edge of the centering ring identifies both the winding and filler materials. The metallic winding material is designated by a solid color. The filler materials are designated by color stripes at equal intervals on the outside edge of the centering ring. Flexitallic color coding meets the industry standard for metal and filler materials listed in ASME B16.20.

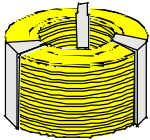
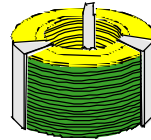
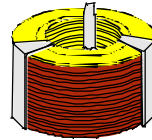
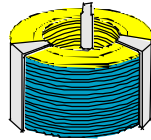
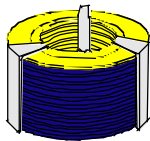
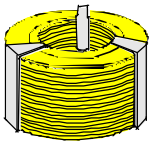
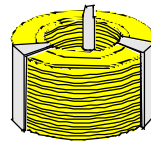
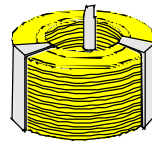
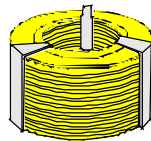
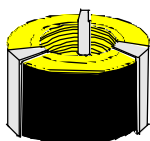
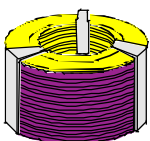
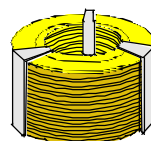
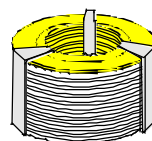
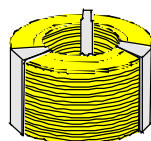
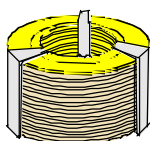
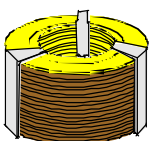
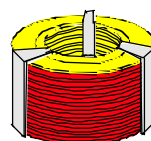
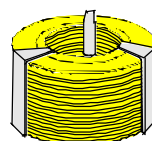
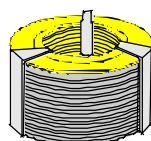
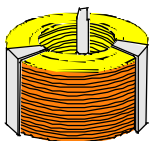
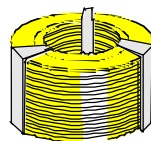
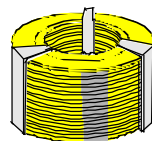
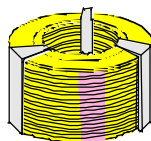
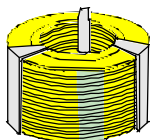
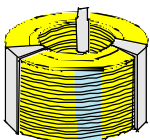
<p>METALLIC WINDING MATERIALS The metallic winding material is designated by a solid color identification around the outside edge of the centering ring.</p>	 304 SS Yellow	 316L SS Green	 317L SS Maroon	 321 SS Turquoise
 347 SS Blue	 310 SS No color	 304L SS No color	 309 SS No color	 430 SS No color
 Alloy 20 Black	 Titanium® Purple	 Inconel® 600/625 Gold	 Incoloy® 800/825 White	 Inconel® X750 No Color
 Hastelloy® C276 Beige	 Hastelloy® B2 Brown	 Nickel 200 Red	 Zirconium No color	 Carbon Steel Silver
 Monel® Orange	<p>NON METALLIC FILLERS The gasket filler materials are designated by a number of stripes placed at equal intervals around the outside edge of the centering ring.</p>	 PTFE White Stripe	 Flexicarb® Gray Stripe	 Flexite Super® Pink Stripe
 Ceramic Light Green Stripe	 Thermiculite™ Light Blue Stripe			

Spiral Wound Gaskets

Manufacturing Capabilities and Tolerances

Recommended Design Parameters			
Gasket Thickness	Maximum Inside Dimension	Recommended Cross-sectional Width	Recommended Compressed Thickness **
0.0625"	Up to 6"	3/8"	0.050" / 0.055"
0.0625"	6" to 15"	1/4"	0.050" / 0.055"
0.100"	10"	1/2"	0.075" / 0.080"
0.125"	Up to 20"	1"	0.090" / 0.100"
0.125" *	20" to 40"	3/4"	0.090" / 0.100"
0.175"	Up to 40"	1"	0.125" / 0.135"
0.175" *	40" to 60"	1"	0.125" / 0.135"
0.175" *	60" to 70"	7/8"	0.125" / 0.135"
0.175" *	70" to 75"	3/4"	0.125" / 0.135"
0.250"	90"	1"	0.180" / 0.200"
0.285"	185"	1"	0.200" / 0.220"

Preferred size range in relation to thickness shown in bold type.

* PTFE filled FLEXITALLIC gaskets in this size range are unstable and are subject to "springing apart" in shipping and handling. Specify next gasket thickness up.

** The recommended compressed thickness is what experience has indicated to be the optimum range in order to achieve maximum resiliency of the gasket. Additional compression of 0.010" may be tolerated on all gasket thicknesses with the exception of the 0.0625" and the 0.100" thick gaskets. This is on the assumption that the flange surface finishes are relatively smooth. Refer to "Flange Surfaces" on page 45. When attempting to contain hard to hold fluids, or pressures above 1000 psi, it is suggested that compression be maintained at the lower range of the recommended compressed thickness.

Tolerances		
Gasket Diameter	Inside Diameter	Outside Diameter
Up to 10"	± 1/64"	± 1/32"
10" to 24"	± 1/32"	± 1/16"
24" to 60"	± 3/64"	± 1/16"
60" & Above	± 1/16"	± 1/16"

Tolerance on gasket thickness is ± 0.005", (measured across metal winding) on all thicknesses.

Sizing Parameters for Spiral Wound Gaskets

Regardless of the type of flange facing in use, FLEXITALLIC gaskets must be sized to ensure the spiral wound element is seated against a flat surface. This is of utmost importance. If a spiral wound element protrudes into the flange bore or extends beyond the raised face, mechanical damage will occur to the gasket during compression, and ultimately failure will result. In addition, should the gasket protrude into the flange bore, the windings can possibly enter the process stream with severe damage resulting to other equipment. With recessed flange facings, limiting dimensions of the gasket are established by dimensions of the groove. On flat or raised face flanges, considerable leeway is available. Note that due to radial growth and clearance requirements, spiral wound gaskets are normally sized differently than other types of gaskets. The following rules will be generally applicable for limiting dimensions of spiral wound components.

Gasket Confined On Both I.D. & O.D.

This is the type facing encountered in tongue and groove joints, and groove to flat face joints. Standard practice is to allow 1/16" nominal diametrical clearance between the I.D. of the groove and the I.D. of the gasket and 1/16" nominal diametrical clearance between the O.D. of the gasket and the O.D. of the groove.*

Gasket Confined On the O.D. Only

This is the type of facing encountered with male and female and female to flat face facings. Standard practice is to allow 1/16" nominal diametrical clearance between the O.D. of the gasket and the O.D. of the groove.* If possible, allow a minimum 1/4" diametrical clearance between the I.D. of the seating surface and the I.D. of the gasket.

Gasket Unconfined On Both the I.D. & O.D.

Allow a minimum 1/4" diametrical clearance between the gasket I.D. and the I.D. of the seating surface. The O.D. should be kept as close as possible to the bolt circle to minimize flange bending moments. If the gasket is used with raised face flanges, allow a minimum 1/4" diametrical clearance between the gasket O.D. and the raised face O.D. and determine the I.D. on the basis of the desired gasket width.

Important - Please note the above rules establish general limits for sizing FLEXITALLIC gaskets. It is frequently necessary to adjust dimensions in order to achieve a proper balance between gasket area and bolt area in order to maintain a reasonable compressive force on the gasket and the minimum gasket factor "m". Please refer to section covering ASME Boiler and Pressure Vessel Code.

Metal Guide Rings

When Flexitallic gaskets are required to be equipped with inner and/or outer metal rings, limitations on the minimum widths of the rings are necessary due to machining limitations and rigidity of the complete assembly. Standard practice is to size outer rings with the outside diameter equal to the diameter of the bolt circle less the diameter of one bolt for rings up to 60" O.D. Above 60" O.D. rings are sized to the diameter of the bolt circle less the diameter of one bolt hole. The table below indicates the minimum width for solid metal rings based on the ring I.D.

Diameter of Ring	Minimum Width**	
	Outer Ring	Inner Ring
Up to 10" Inside Diameter	3/8"	1/4"
10" to 24" Inside Diameter	7/16"	3/8"
24" to 50" Inside Diameter	1/2"	3/8"
50" to 70" Inside Diameter	5/8"	1/2"
70" and Larger	3/4"	1/2"

*Note: 1/16" nominal O.D. clearance for gaskets up to 60" O.D.; from 60" O.D. to 80" O.D., allow 5/64"; above 80" O.D allow 3/32" nominal O.D. clearance.

**Note: Where space is limited and narrower ring widths are necessary, it may be possible to supply inner and outer spacer rings of metal spiral wound construction. Consult FLEXITALLIC Technical Department for advice.

Sizing Parameters for Spiral Wound Gaskets

Non-circular Spiral Wound Gaskets

Spiral wound gaskets can be fabricated in non-circular shapes within limitations. As a general rule, if the ratio of the major I.D. to the minor I.D. exceeds 3 to 1, and should any of these sides approach a straight line, it may not be possible to manufacture a stable spiral wound gasket. Our product requires a definite radius or curvature to give it inherent strength and stability and to prevent it from springing apart. Any application requiring a non-circular gasket should be submitted to our Technical Department for review to determine the feasibility of producing a satisfactory gasket as early as possible in the design stage.

The comments above and on the previous page relating to availability of sizes and recommended clearances for proper sizing of FLEXITALLIC gaskets are general in nature. Many applications will arise where the recommended clearances are impractical due to space limitation on the flange. Frequently, clearances between gasket sealing member and grooves must be reduced in order to effectively maintain a seal under operating conditions, particularly when the higher pressures are encountered. Under such circumstances, FLEXITALLIC engineers should be consulted prior to finalizing designs.

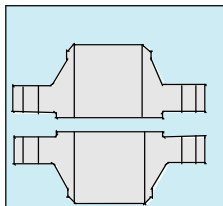
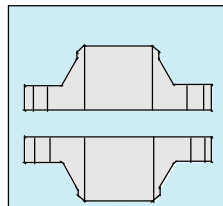
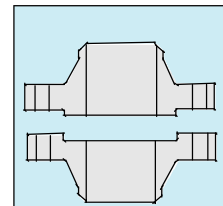
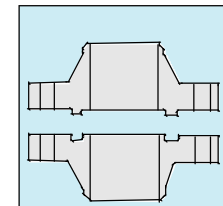
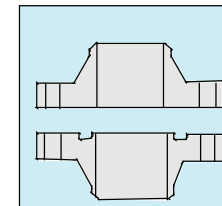
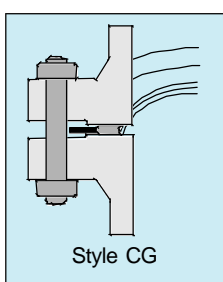
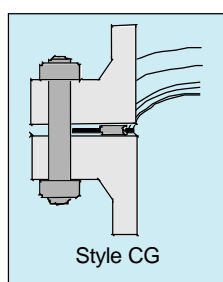
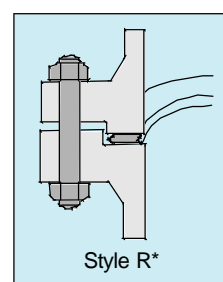
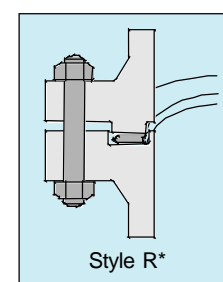
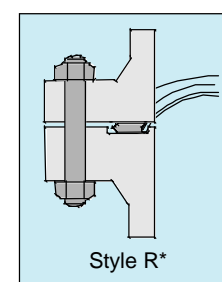
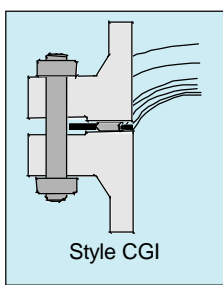
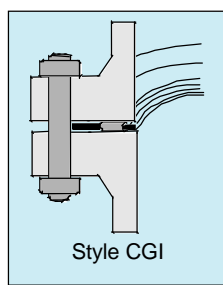
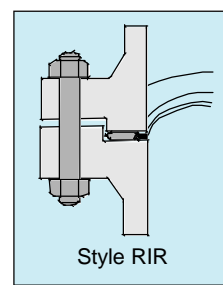
<p>Flange Face</p>	 <p>Raised Face</p>	 <p>Flat Face</p>	 <p>Male and Female</p>	 <p>Tongue and Groove</p>	 <p>Flat Face to Recess</p>
<p>Recommended Gasket Style For general duties</p>	 <p>Style CG</p>	 <p>Style CG</p>	 <p>Style R*</p>	 <p>Style R*</p>	 <p>Style R*</p>
<p>Recommended Gasket Style For high pressure/ temperature duty, also for gaskets with PTFE filler, corrosive or fluctuating pres- sure or temperature service conditions.</p>	 <p>Style CGI</p>	 <p>Style CGI</p>	 <p>Style RIR</p>	<p>*NOTE: It is essential that Style R gaskets are fitted with a compression stop. Without a correctly dimensioned stop the gasket can easily be over-compressed resulting in failure. To provide a compression stop the depth of the tongue, groove or recess should be controlled to provide optimum compressed gasket thickness with metal to metal contact on the flange faces (see table on Page 27).</p>	

Flexpro[®] Gaskets

The Flexpro (formerly known as the Kammprofile) gasket offers a safe, effective seal under the most severe operating conditions on both standard pipework and special applications.

The Flexpro gasket offers excellent flexibility and recovery characteristics, allowing seal integrity under pressure and temperature fluctuations, temperature differential across the flange face, flange rotation, bolt stress relaxation and creep.

The Flexpro is a two part assembly, consisting of a precision serrated metallic core with the addition of soft gasket sealing materials bonded to each face. The soft gasket sealing material provides initial low stress gasket seating, while the serrated geometry of the metallic core enhances sealing performance by means of inducing stress concentration on the sealing layers, containing these sealing faces within the radial grooves. This minimizes lateral flow and ensures the applied load is confined upon the gasket sealing faces. A further function of the metallic core is to provide exceptional gasket rigidity and blow out resistance, as well as offering an integral compression stop. Flexpro gaskets are suitable for Class 150 to 2500 service.

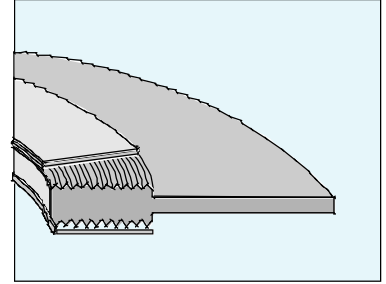

As standard, graphite is the preferred sealing face material, due to its excellent stability and flow characteristics. Other soft facing materials available are Thermiculite, PTFE, Sigma, Non-asbestos fiber, and soft metals. The metallic core must be selected to suit the application design conditions and the media to be sealed, with both chemical resistance properties and temperature stability characteristics taken into account.

A full range of metallic core materials are available, from the relatively low cost carbon steels, through the range of stainless steels up to the "exotic" alloys. 316 L material is considered standard. For a full listing, please refer to the table below.

Flexpro gaskets are available for non standard flange applications such as heat exchangers, pumps, and valves. For heat exchanger applications, Flexpro gaskets can be designed to suit TEMA male and female flange arrangements as well as tongue and groove flanges requiring any type of pass bar configuration.

The Flexpro gasket is available with two types of serrated core profiles: the DIN profile and the standard (Shallow) profile.

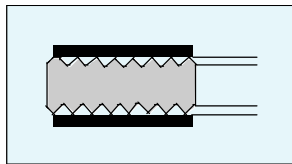

Style PN

Style PN Flexpro gaskets are selected for use in confined locations, including male and female, tongue and groove, and recessed flange arrangements.

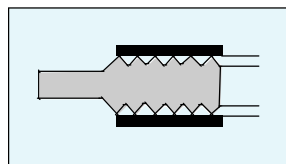

Style ZG

Variation of the PN Flexpro, utilizing an integral outer locating ring for correct gasket positioning within the mating flange bolt circle. Style ZG Flexpro gaskets are recommended for use on standard raised face and flat face flange assemblies.

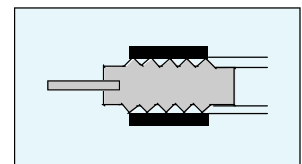

Style ZA

The Style ZA Flexpro is a slight variation of the Style ZG. The integral outer locating ring is replaced by a loose fitting independent ring which is preferred where flange differential radial thermal expansion may be encountered. These rings may also be spot welded.

Flexpro Gasket Materials			
Metallic Core Materials			Soft Facing Materials
Type 316L SS	Carbon Steel	Hastelloy C276	Flexicarb
Type 304 SS	Monel	Aluminum	Thermiculite
Type 309 SS	Inconel 600	Copper	Non-asbestos Fiber
Type 310 SS	Inconel 625	Brass	PTFE
Type 317L SS	Inconel X-750	Nickel 200	Sigma
Type 321 SS	Incoloy 800	Alloy 20	Soft Metals
Type 347 SS	Incoloy 825	Duplex	
Type 430 SS	Hastelloy B2	Titanium	

MRG Gaskets

An MRG (Metal Reinforced Gasket) is a rigid laminated gasket consisting of soft layers bonded to each face of a solid metal core by a high temperature/chemical resistant synthetic bonding agent.

While the solid metal core prevents gasket blowout, it provides high strength and rigidity; and the soft facings provide for an exceptional seal. The soft facing material flows easily into the flange faces allowing a high integrity seal, even under low applied seating stresses.

The metal core material is selected to suit the application design conditions and the media to be sealed. A wide range of core materials are available, from the relatively low cost carbon steels, through the range of stainless steels up to the "exotic" alloys. For chemical resistance and temperature stability purposes, the correct core material must always be selected.

Standard core material is either 304 or 316 stainless steel, and standard core thickness is 1/8".

The soft gasket facings can be Flexicarb, PTFE, Sigma, Thermiculite, or non-asbestos fiber gasket material. However, Flexicarb is the standard and most widely used facing material supplied with the MRG gasket.

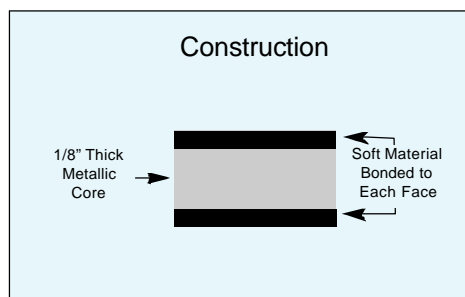

Soft Facing Materials	
Soft Material	Standard Thickness (in.)
Flexicarb	.020
Thermiculite	.020
PTFE	.015
Sigma	.030
Non-Asbestos Fiber	.020

Other thicknesses are available on request.

Suitable up to pressure Class 300, the MRG is widely used in the chemical and petrochemical industries, where a high temperature/corrosion resistant, high integrity joint is required. Although the MRG gasket can be utilized on standard flange applications in place of conventional non-asbestos sheet gaskets, or in some instances spiral wound gaskets, it is on special type assemblies where the MRG is mainly utilized. Due to laser manufacturing techniques, any type of gasket shape can be produced.

Where restricted or limited space precludes the use of spiral wound gaskets or limited bolt load is available to seat the gasket, the MRG's narrow cross sectional width makes it ideal for use in floating head arrangements of heat exchangers.

Ring Type Joints

The ring type joint was initially developed for use in the petroleum industry, where high pressure/temperature applications necessitated the need for a high integrity seal. They are mainly used in the oil field on drilling and completion equipment. Ring type joints are also commonly used on valves and pipework assemblies, along with some high integrity pressure vessel joints.

Style R

The Style R ring type joint is manufactured in accordance with API 6A and ASME B16.20, to suit API 6B and ASME B16.5 flanges.

Style R ring type joints are manufactured in both oval and octagonal configurations. Both styles are interchangeable on the modern flat bottom groove, however only the oval style can be used in the old type round bottom groove.

Style R ring type joints are designed to seal pressure up to 6,250 psi in accordance with ASME B16.5 pressure ratings and up to 5,000 psi in accordance with API 6A pressure ratings.

Style RX

The Style RX ring type joint is manufactured in accordance with API 6A and ASME B16.20, to suit API 6B and ASME B16.5 flanges.

The Style RX is designed to fit the modern flat bottom groove, and is interchangeable with the standard Style R ring type joint. However, since the Style RX is significantly taller than a Style R, larger flange make up distances will result.

Style RX ring type joints are designed to seal pressures up to 6,250 psi in accordance with ASME B16.5 pressure ratings, and up to 5,000 psi in accordance with API 6A pressure ratings. Selected sizes incorporate a pressure passage hole to allow for pressure equalization each side of the sealing faces.

Style BX

The Style BX ring type joint is manufactured in accordance with API 6A.

All BX ring type joints incorporate a pressure passage hole to allow for pressure equalization each side of the sealing faces. On assembly, metal to metal contact of the flange faces is achieved. The Style BX is not interchangeable with any other style, and is only suited for API 6BX flanges. Style BX ring type joints are designed to seal pressure up to 20,000 psi in accordance with API 6A pressure ratings.

Styles SRX and SBX

Styles SRX and SBX are derived from Styles RX and BX, and are produced in line with the API Standard 17 D for use on subsea wellhead and Christmas tree equipment.

Style R

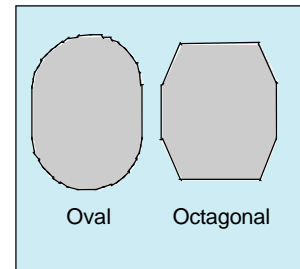

Style RX

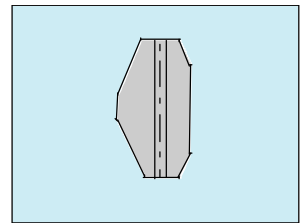

Style BX

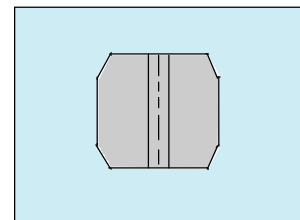

Ring Type Joints

How They Work

Under axial compressive load, ring type joints plastically deform and flow into the irregularities of the flange groove. Since the load bearing area of the ring type joint is relatively small, very high surface stresses result between the sealing faces of the ring type joint and the groove. These stresses are further increased on the Style RX and BX rings which allows very high internal pressures to be sealed.

Since ring type joints are solid metal, their recovery characteristics are poor. The seal is maintained by the action of axial load upon the gasket.

Surface Finish Requirements

With all metal to metal type seals, it is imperative that the gasket and groove sealing faces are free from indentations, score marks, tool/chatter marks and other imperfections. The surface finish of the gasket and groove sealing faces is also critical and should not exceed the following:

Style R and RX	63 microinches RMS maximum (1.6 micrometer Ra) Ra 1.6 micrometers
Style BX	32 CLA microinches RMS maximum (0.8 micrometer Ra) Ra 0.8 micrometers

Reuse

Ring type joints are designed to have a limited amount of positive interference, which ensures that the ring type joint seats correctly into the groove on compression. Their reuse is not recommended for two reasons:

- The initial seating of the gasket will be impaired.
- When the gasket is plastically deformed, work hardening of the external metal surface occurs. This may result in permanent damage to the groove.

Hardness of Materials

On compression of the flange assembly, it is imperative that the ring type joint be significantly softer than the flange groove so that the gasket plastically deforms and not the groove. The use of harder ring type joints can result in flange groove damage. For this reason, ring type joints are supplied with the following maximum hardness values:

Material	Werkstoff Number	Maximum Hardness		Identification
		Brinell*	Rockwell B†	
Soft Iron		90	56	D
Low Carbon Steel		120	68	S
4 - 6% Chrome 1/2% Moly.		130	72	F5
Type 304 Stainless Steel	1.4301	160	83	S304
Type 316 Stainless Steel	1.4401	160	83	S316
Type 347 Stainless Steel	1.4550	160	83	S347
Type 410 Stainless Steel	1.4006	170	86	S410

* Measured with 3000Kg load except soft iron which is measured with 500Kg load
 † Measured with 100 Kg load and 1/16" diameter ball.

Some materials can be supplied with NACE certification on request.

Protective Coating

In accordance with API Specifications, soft iron, low carbon steel, and other ferrous materials ring type joints are protected from corrosion with electroplated zinc or cadmium to a maximum thickness of 0.0005". Alternative material coatings can be supplied on request.

Special Ring Type Joints

For critical and non standard applications, where ring type joints are unsuitable in their standard form, Flexitallic offers a range of specialized ring type joint gaskets to suit the needs of the petrochemical industry.

Style R Ring Type Joints with PTFE Inserts

Oval and octagonal ring type joints can be supplied with a PTFE insert which is located in a machined recess in the bore of the gasket. The insert reduces turbulent flow across adjoining flanges and also eliminates flange/gasket erosion which can occur with high velocity fluids.

Style RX Ring Type Joints with PTFE Inserts

Style RX ring type joints can also be supplied with PTFE inserts, in order to reduce turbulent flow and eliminate gasket/flange erosion. The insert is specially designed with radially drilled pressure passage holes so that the self sealing performance of the RX Ring Joint is not impaired.

Rubber Coated Ring Type Joints

This is an oval ring type joint which is totally enclosed in a nitrile rubber coating. The ring type joint material is usually soft iron or low carbon steel. This type of gasket has three main functions:

- It is used in pressure testing to minimize damage to flanges.
- The rubber contact points provide additional seals while protecting the flange surfaces.
- It provides increased assurance against corrosion, which can occur between conventional ring type joints and the engaged surfaces of the groove.

Transition Ring Type Joints

These are combination rings which consist of two different sizes having the same pitch circle diameter. They are used for sealing ring type joint flanges where the mating flanges have different ring groove diameters. Transition ring type joints are available with either oval or octagonal facings.

Blind Ring Type Joints

Special ring type joints can be manufactured to blank off flanges and pipework. They consist of standard ring type joints with integral solid metallic centers.

Flange Guards

Flange guards are supplied to suit all API, ASME, BS and MSS SP44 ring type joint flanges. Flange guards are manufactured from closed cell neoprene foam, which compresses readily under load. Once assembled, they protect the outside diameter of the ring type joint from corrosion, i.e. salt spray.

Style R with PTFE Inserts

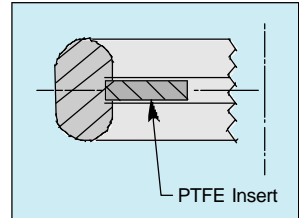

Style RX with PTFE Inserts

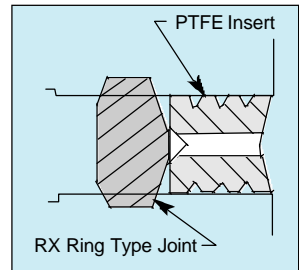

Rubber Coated RTJ

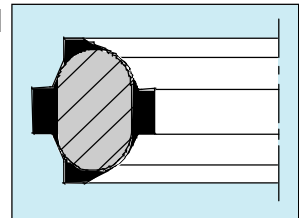

Transition RTJ

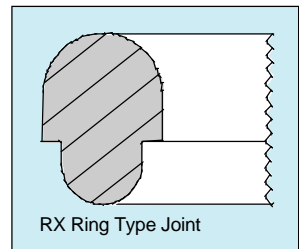

Blind RTJ

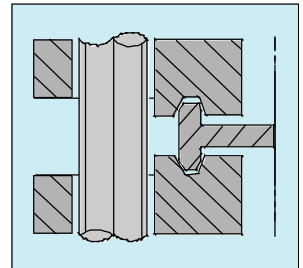

Flange Guards



Lens Rings

In certain applications, the specification of a high integrity metallic seal has usually lead to the selection of the Lens Ring concept, rather than the more generally recognized ring type joint solution. The Lens Ring is covered solely by the DIN 2696 specification. However, ASME B16.5 and other flange types can be modified to accept the Lens Ring.

The Lens Ring provides a metallic gasket design incorporating spherical seating faces designed to suit specifically mating flange recesses, providing the user with a high integrity, high pressure/temperature metal to metal seal.

As with all metallic gaskets, the Lens Ring material should be specified softer than the flange material, thus ensuring applied compressive load leads to the elastic/plastic deformation of the lens ring and not the flange sealing face. The distribution of high compressive loads leads to the spread of the gasket facings, ensuring over stressing of the gasket is prevented.

In accordance with DIN 2696 general materials are limited to a range of specified carbon steels and stainless steel grades, although alternative grades are available upon request. Flexitallic requires a detailed drawing be supplied when ordering non standard Lens Rings.

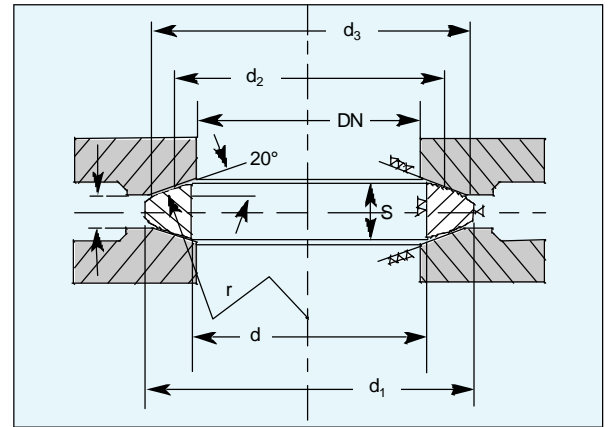

DIMENSIONS IN MILLIMETERS

NPS size DN	d		d ₁	S for d max	d ₂ middle contact diameter	r	d ₃	x
	min	max						
Nominal pressure PN64 - 400								
10	10	14	21	7	17.1	25	18	5.7
15	14	18	28	8.5	22	32	27	6
25	20	29	43	11	34	50	39	6
40	34	43	62	14	48	70	55	8
50	46	55	78	16	60	88	68	9
65	62	70	102	20	76.6	112	85	13
80	72	82	116	22	88.2	129	97	13
100	94	108	143	26	116	170	127	15
125	116	135	180	29	149	218	157	22
150	139	158	210	33	171	250	183	26
Nominal Pressure PN64 and 100								
(175)	176	183	243	31	202.5	296	218	28
200	198	206	276	35	225	329	243	27
250	246	257	332	37	277.7	406	298	25
300	295	305	385	40	323.5	473	345	26
350	330	348	425	41	368	538	394	23
400	385	395	475	42	417.2	610	445	24
Nominal pressure PN160 - 400								
(175)	162	177	243	37	202.5	296	218	21
200	183	200	276	40	225	329	243	25
250	230	246	332	46	277.7	406	298	25
300	278	285	385	50	323.5	473	345	30
Avoid nominal pipe sizes in brackets.								

Weld Gaskets

Another gasket concept with origins from the German industrial market are weld gaskets. As standard, two variants exist; Weld Membrane Gaskets in accordance with DIN 2695 and Weld Ring gaskets.

Weld Membrane Gaskets

The Weld Membrane Gasket consists of two similar rings each of 0.157" (4mm) thickness. For chemical compatibility and in order to ensure controlled thermal conductivity and weld compatibility, the gasket material must always be the same as the flange material. Each ring is individually welded to its mating flange. Upon flange assembly, a second welding operation joins the two rings at their outer diameter which provides for a fully welded joint.

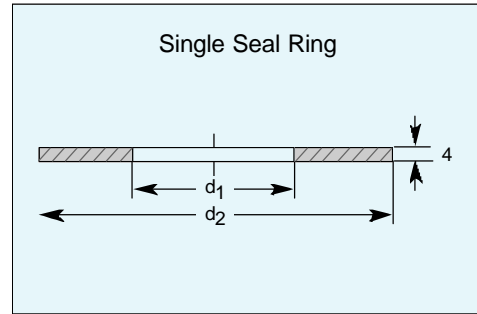
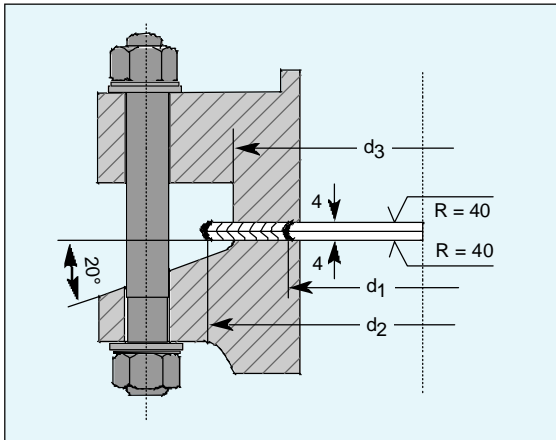

Weld Ring Gaskets

As with Weld Membrane Gaskets, Weld Ring Gaskets are used in pairs. As standard, each ring is manufactured to similar materials to that of the flange, thus ensuring full compatibility. All welding is conducted on the outside of the gasket and flange, thus ensuring ease of location, especially in restricted applications where space is limited. Two styles exist, Style SR and Style SRL. Style SRL is recommended when there is flange differential radial expansion.

Style SR

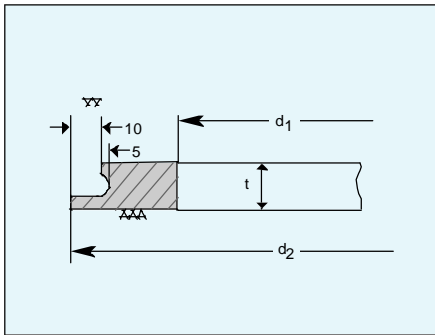

Style SRL

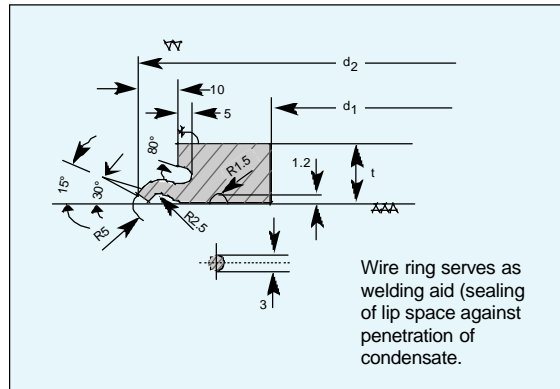

SECTION II

Joint Integrity Calculations

This section is designed to enable a flange designer or gasket user to:

1. Calculate a bolt stress required for a particular gasket in a known flange.
2. Modify both gasket and bolting parameters in the relevant calculations to arrive at a suitable gasket type and dimension, and bolt pattern to suit a given application.

A Torque Guide is included to enable the user to obtain a torque figure once the bolt stress has been calculated.

See the installation section for a controlled bolting procedure in which to apply these torque values.

Gasket Type

The engineer must always be aware of the abilities and limitations of the gasket types and materials. Factors such as blow out resistance, creep resistance, stress retention, recovery characteristics and cost must be considered.

Application

When determining the type of gasket to be used, design pressures and temperatures must always be considered. Media will further dictate gasket selection and what materials may or may not be utilized, ensuring chemical compatibility. Always consider special conditions such as thermal cycling, thermal shock, vibration, and erosion.

Flange Design

Attention to the flange design is critical when designing a gasket. Flange configuration, available bolt load and materials all have obvious effects on gasket selection. Flange configuration determines the style and basic dimensions of the gasket. Compatibility between flange and gasket material must be ensured, thus minimizing the possibility of galvanic corrosion.

When a joint assembly is placed in service, three basic forces become active and affect its sealing qualities.

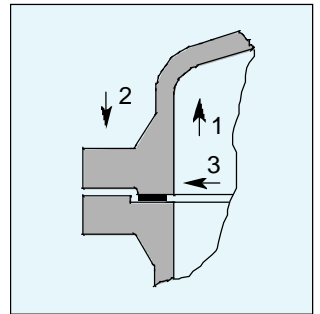

1) END FORCE -	which originates with the pressure of confined gases or liquids that tends to separate the flange faces.
2) GASKET LOAD -	the function of the bolting or other means which applies force upon the flange faces to compress the gasket and withstand internal pressure
3) INTERNAL PRESSURE -	force which tends to move, permeate or bypass the gasket.

Taking the above factors into consideration, attention must be paid to the initial force applied to a joint. Firstly, the applied preload must be sufficient to seat the gasket upon the flange faces, compensating for any surface imperfections which may be present. Secondly, the force must be sufficient to compensate for the internal pressures acting against the flange assembly. i.e. the hydrostatic end force and internal pressure. Finally, the applied force must be sufficient to maintain a satisfactory residual load upon the joint assembly.

ASME Boiler and Pressure Vessel Code Calculations

Section VIII of the ASME Boiler & Pressure Vessel Code, establishes criteria for flange design and suggests values of "m" (gasket factor) and "y" (minimum gasket seating stress) as applied to gaskets. For the most part, the defined values have proven successful in actual applications. However, much confusion exists regarding these values, primarily due to a misunderstanding of the definitions of the terms and their significance in practical applications. Mandatory Appendix II, in Section VIII of the Boiler Code, requires in the design of a bolted flange connection, complete calculations shall be made for two separate and independent sets of conditions.

Operating Conditions

Condition one (1) requires a minimum load be determined in accordance with the following equation:

$$(1) \quad Wm1 = \frac{3.14G^2P}{4} + 2b \ 3.14GmP$$

This equation states the minimum required bolt load for operating conditions and is the sum of the hydrostatic end force, plus a residual gasket load on the contact area of the gasket times a factor times internal pressure. Stated another way, this equation requires the minimum bolt load be such that it will maintain a residual unit compressive load on the gasket area that is greater than internal pressure when the total load is reduced by the hydrostatic end force.

Gasket Seating

Condition two (2) requires a minimum bolt load be determined to seat the gasket regardless of internal pressure and utilizes a formula:

$$(2) \quad Wm2 = 3.14bGy$$

The "b" in these formulae is defined as the effective gasket width and "y" is defined as the minimum seating stress in psi. For example, Section VIII of the Boiler Code suggests a minimum "y" value for a spiral wound gasket of 10,000 psi (Winter 1976 Addenda). These design values are suggested and not mandatory. The term "b" is defined as:

$$b = b_0 \text{ when } b_0 \leq 1/4" \quad b = 0.5 \sqrt{b_0} \text{ when } b_0 > 1/4"$$

After Wm1, and Wm2 are determined, the minimum required bolt area Am is determined as follows:

$$Am = \frac{Wm1}{Sb} \text{ where } Sb \text{ is the allowable bolt stress at operating temperature, and}$$

$$Am2 = \frac{Wm2}{Sa} \text{ where } Sa \text{ is the allowable bolt stress at atmospheric temperature.}$$

Then Am is equal to the greater of Am1 or Am2. Bolts are then selected so the actual bolt area, Ab, is equal to or greater than Am.

At this point, it is important to realize the gasket must be capable of carrying the entire compressive force applied by the bolts when prestressed unless provisions are made to utilize a compression stop in the flange design or by the use of a compression gauge ring. For this reason, FLEXITALLIC's standard practice is to assume W is equal to Ab Sa.

We are then able to determine the actual unit stress on the gasket bearing surface. This unit stress Sg is calculated as follows:

$$(3) \quad Sg \text{ (psi)} = \frac{Ab Sa}{.785 [(d_o - .125)^2 - (d_i)^2]}$$

*Note: Based on 4.5mm (.175") thick spiral wound gasket. The "v" or Chevron shape on the gasket O.D. is not part of the effective seating width, therefore .125" is subtracted from the actual gasket O.D.

Using the unit stress we can assign construction details which will lead to the fabrication of a gasket having sufficient density to carry the entire bolt load.

ASME Boiler and Pressure Vessel Code Calculations

Gasket Seating Stress "Y"

Defined as the applied stress required to seat the gasket upon the flange faces. The actual required seating stress is a function of flange surface finish, gasket material, density, thickness, fluid to be sealed and allowable leak rate.

Gasket Factor "m"

Appendix II, Section VIII, of the Boiler Code makes the statement the "m" factor is a function of the gasket material and construction. We do not agree entirely with this interpretation of "m". Actually, the gasket does not create any forces and can only react to external forces. We believe a more realistic interpretation of "m" would be "the residual compressive force exerted against the gasket contact area must be greater than internal pressure when the compressive force has been relieved by the hydrostatic end force". It is the ratio of residual gasket contact pressure to internal pressure and must be greater than unity otherwise leakage would occur. It follows then, the use of a higher value for "m" would result in a closure design with a greater factor of safety. Experience has indicated a value of 3 for "m" is satisfactory for flanged designs utilizing Spiral Wound gaskets regardless of the materials of construction. In order to maintain a satisfactory ratio of gasket contact pressure to internal pressure, two points must be considered. First, the flanges must be sufficiently rigid to prevent unloading the gasket due to flange rotation when internal pressure is introduced. Secondly, the bolts must be adequately prestressed. The Boiler Code recognizes the importance of pre-stressing bolts sufficiently to withstand hydrostatic test pressure. Appendix S, in the Code, discusses this problem in detail.

Notations

A_b	= Actual total cross sectional root area of bolts or section of least diameter under stress; square inches
A_m	= Total required cross sectional area of bolts, taken as greater of A_{m1} or A_{m2} ; square inches
A_{m1}	= Total required cross sectional area of bolts required for operating conditions; square inches
A_{m2}	= Total required cross sectional area of bolts required for gasket seating; square inches
b	= Effective sealing width; inches
b_o	= Basic gasket seating width; inches
$2b$	= Joint-contact-surface pressure width; inches
G	= Diameter of location of gasket load reaction; inches
m	= Gasket factor
N	= Radial flange width of spiral wound component
P	= Design pressure; psi
S_a	= Allowable bolt stress at atmospheric temperature; psi
S_b	= Allowable bolt stress at design temperature; psi
W	= Flange design bolt load; pounds
W_{m1}	= Minimum required bolt load for operating conditions; pounds
W_{m2}	= Minimum required bolt load for gasket seating; pounds
y	= Minimum gasket seating stress; psi
S_g	= Actual unit stress at gasket bearing surface; psi
d_o	= Outside diameter of gasket; inches
d_i	= Inside diameter of gasket; inches

The ASME boiler and pressure vessel code is currently under review by the Pressure Vessel Research Council. Details of these proposed improvements, including the effects on gasket design procedures are highlighted on page 42.

ASME Boiler and Pressure Vessel Code Calculations

Gasket Materials and Contact Facings

Gasket factors (*m*) for Operating Conditions and Minimum Design Seating Stress (*Y*)

Gasket Material	Gasket Factor (<i>m</i>)	Minimum Design Seating Stress (<i>Y</i>) (psi)	Sketches and Notes	Seating Width (See Table)	
				Gasket Group	Column
Self-Energizing Types O-rings, metallic, elastomer, and other gasket types considered as self-sealing	0	0			
Elastomers without fabric Below 75A Shore Durometer 75A or higher Shore Durometer	0.50 1.00	0 200		(1a), (1b) (1c), (1d), (4), (5)	II
Elastomers with cotton fabric insertion	1.25	400			
Vegetable fiber	1.75	1100			
Flexicarb based products MRG Flexpro NR SR ST	2.00 2.00 2.00 2.00 2.00	2,500 2,500 2,500 2,500 2,500			
Spiral wound metal, with filler	3.00	10,000		(1a), (1b)	
Spiral wound Style LS, Flexicarb Filled/PTFE filled/Thermiculite filled	3.00	5,000			
Corrugated metal with filler or Corrugated metal jacketed with filler	2.50 2.75 3.00 3.25 3.50	2900 3700 4500 5500 6500	 	(1a), (1b)	
Corrugated metal	2.75 3.00 3.25 3.50 3.75	3700 4500 5500 6500 7600		(1a), (1b), (1c), (1d)	
Flat metal jacketed, with filler	3.25 3.50 3.75 3.50 3.75 3.75	5500 6500 7600 8000 9000 9000		(1a) ₂ , (1b) ₂ , (1c), (1d), (2)	
Grooved metal	3.25 3.50 3.75 3.75 4.25	5500 6500 7600 9000 10100		(1a), (1b), (1c), (1d), (2), (3)	
Solid flat metal	4.00 4.75 5.50 6.00 6.50	8800 13000 18000 21800 26000		(1a), (1b), (1c), (1d), (2), (3), (4), (5)	I
Ring Joint	5.50 6.00 6.50	18000 21800 26000		(6)	



Notes:

This table gives a list of many commonly used gasket materials and contact facings with suggested design values of *m* and *y* that have generally proved satisfactory in actual service when using effective gasket seating width *b* given in the table on the next page. The design values and other details given in this table are suggested only and are not mandatory.

The surface of a gasket having a lap should not be against the nubbin.

ASME Boiler and Pressure Vessel Code Calculations

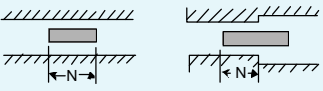
Effective Gasket Seating Width - See Note (1)

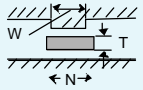
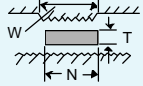
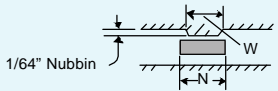
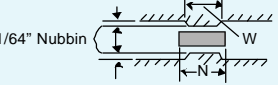
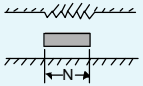
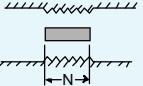
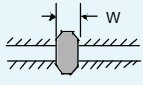
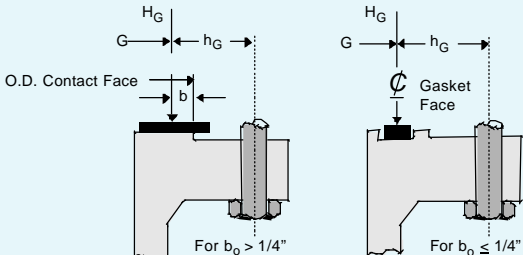
Facing Sketch Exaggerated	Basic Gasket Seating Width, b_0	
	Column I	Column II
(1a) 	$\frac{N}{2}$	$\frac{N}{2}$
(1b) 		
See Note (2)		
(1c)  $w \leq N$	$\frac{W + T}{2} ; \left(\frac{W + N}{4} \text{ max.} \right)$	$\frac{W + T}{2} ; \left(\frac{W + N}{4} \text{ max.} \right)$
(1d)  $w \leq N$		
See Note (2)		
(2)  $w \leq N/2$	$\frac{W + N}{4}$	$\frac{W + 3N}{8}$
(3)  $w \leq N/2$	$\frac{N}{4}$	$\frac{3N}{8}$
(4)  $w \leq N/2$	$\frac{3N}{8}$	$\frac{7N}{16}$
See Note (2)		
(5)  $w \leq N/2$	$\frac{N}{4}$	$\frac{3N}{8}$
See Note (2)		
(6)  $w \leq N/2$	$\frac{W}{8}$	
Effective Gasket Seating Width, b		
$b = b_0$, when $b_0 \leq 1/4"$; $b = 0.5 \sqrt{b_0}$, when $b_0 > 1/4"$		
Location of Gasket Load Reaction		
		

Notes:
 (1) The gasket factors listed only apply to flanged joints in which the gasket is contained entirely within the inner edges of the bolt holes.
 (2) Where serrations do not exceed 1/64" depth and 1/32" width spacing, sketches (1b) and (1d) shall be used.

PVRC METHOD

Current gasket design calculations for bolted joints such as ASME VIII, DIN 2505, etc., have many shortcomings surrounding the expected tightness and optimum operating stress levels to ensure against joint leakage. In general, current design methods only ensure that the optimum bolt load is available to seat the gasket and accommodate the hydraulic loads created by the internal pressure. Little information is given regarding the tightness of the joint in service or the optimum level of gasket stress to fulfill the legislative, environmental and company emission requirements at the source of application.

Flexitallic financially supports, and is actively involved in the research efforts of the ASME's Pressure Vessel Research Council (PVRC) to review and update current gasket design methodology. The PVRC has, through many years of research and development (involving hundreds of actual gasket tests), conceived a new philosophy that addresses the mechanisms of

sealing that will benefit gasket manufacturers, vessel designers and the operators of process equipment in general. The result is a package that recommends minimum levels of gasket assembly stress to fulfill the operational requirements of the user. The new procedure is similar to the existing ASME Section VIII calculation, except it incorporates new gasket factors (to replace the traditional m & Y gasket factors) that have been determined through an extensive test program.

The new gasket factors are (Gb), (a), and (Gs).

(Gb) and (a) represent the initial gasket compression characteristics and relate to the initial installation, while (Gs) represents the unloading characteristics typically associated with the operating behavior.

The PVRC method has been developed over the years using the following parameters for bolted joint designs and determining gasket constants:

1. Determine the tightness class 'Tc' that corresponds to the acceptable leak rate for the application (legislative, environmental, or company emission legislation).
T2: Standard; represents a mass leak rate per unit diameter of 0.002 mg/sec/mm-dia.
T3: Tight; represents a mass leak rate per unit diameter of 0.00002 mg/sec/mm-dia.
2. Select the tightness constant that corresponds to the chosen tightness class
C = 1.0 for tightness class T2 (Standard).
C = 10.0 for tightness class T3 (Tight).
3. Select the appropriate gasket constants (Gb), a, and (Gs) for the gasket style and material, (see table, page 43).
4. Determine gasket parameters (N), (b_o), (b), and (G) as per table (page 40).
5. Gasket seating area, $A_g = 0.7854(OD^2-ID^2)$.
6. Hydraulic area, $A_i = 0.7854G^2$
7. Minimum required tightness, $T_{pmin} = 0.1243 \times C \times P_d$, $P_d =$ Design Pressure
8. Assembly Tightness $T_{pa} = 0.1243 \times C \times P_t$, $P_t =$ Test Pressure (Typically 1.5 x P_d)
9. Tightness Parameter Ratio, $T_r = \text{Log}(T_{pa})/\text{Log}(T_{pmin})$
10. Gasket Operating Stress, $S_{m1} = G_s[G_b/G_s \times T_{pa}^a]^{1/T_r}$

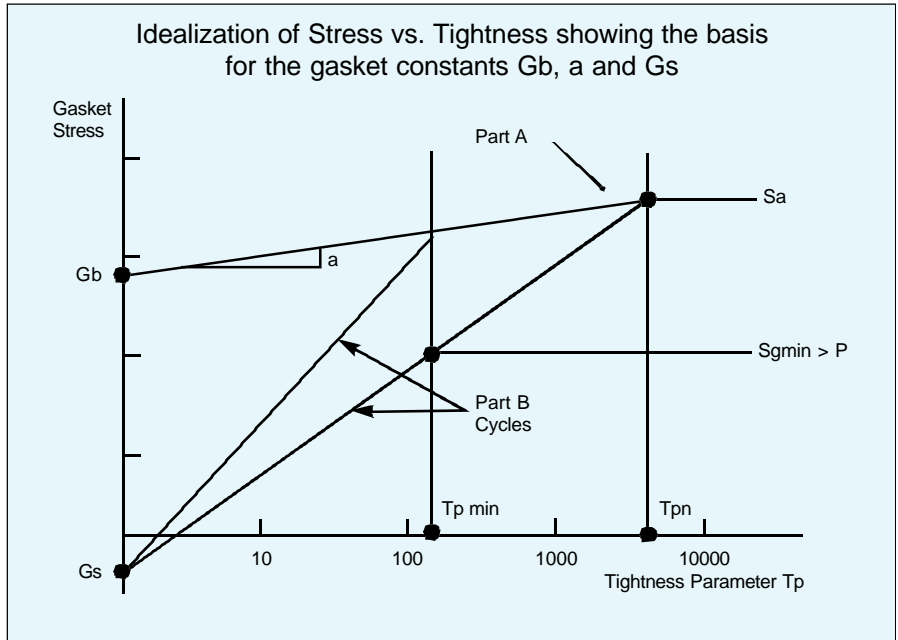

PVRC Method

11. Gasket Seating Stress, $S_{m2} = G_b (T_{pa}^a) / (e \times 1.5) - P_d (A_i/A_g)$
 $e = 0.75$ for manual bolt up
 $e = 1.0$ for hydraulic tensioners & ultrasonic
12. Design factor, $M_o =$ the greater of $2, S_{m1}/P_d$ or S_{m2}/P_d
13. Design Bolt load, $W_{mo} = A_g \times S_{mo} + A_i \times P_d$
 S_{mo} is the larger of $S_{m1}, S_{m2}, 2P, S_L$

S_L = A minimum permitted value of operating gasket stress equal to 90% of the minimum gasket stress in the test that determined the gasket constants. It is 6.21 MPa (900 psi) for the standard and soft ROTT test procedures, and 10.3 MPa (1500 psi) for the hard gasket procedure.

Gasket Factors

Note: All data presented in this table are based on currently available published information. PVRC and ASME continue to refine data reduction techniques, and values are therefore subject to further review and revisions.

Type	Material	G_b (psi)	a	G_s (psi)
Spiral Wound 'LS' (Class 150 & 300)	SS/Flexicarb	598	0.385	0.03
	SS/PTFE	698	0.249	0.00128
Spiral Wound (Class 150 to 2500)	SS/Flexicarb	2300	0.237	13
	SS/Flexite Super	2600	0.230	15
	SS/Thermiculite	2,120	0.190	49
MRG Carrier Ring Flexpro	SS/Flexicarb	813	0.338	0.2
	SS/Flexicarb	1251	0.309	11
	SS/Flexicarb	387	0.334	14
	SS/Thermiculite	-	-	-
Sheet Gaskets (Class 150 to 300)	Flexicarb	1047	0.354	0.07
	Flexicarb NR	818	0.347	0.07
	AF 2100	1767	0.22	65.19
	SF 2400/2800	290	0.383	2.29
	SF 3300	2360	0.190	50.25
	Sigma 500	4	0.804	0.115
	Sigma 511	209	0.356	0.00498
	Sigma 522	472	0.250	0.037
	Sigma 533	115	0.382	0.000065
	Thermiculite 815	1906	0.2	456.12
Corrugated Gasket	Soft Iron	3000	0.160	115
	Stainless Steel	4700	0.150	130
	Soft Copper	1500	0.240	430
Metal Jacketed	Soft Iron	2900	0.230	15
	Stainless Steel	2900	0.230	15
	Soft Copper	1800	0.350	15
Metal Jacketed Corr.	Soft Iron	8500	0.134	230

Please contact Flexitallic Engineering Department for the gasket constants of newly developed gaskets.

SECTION III

Gasket Installation

A FLEXITALLIC gasket will provide a reliable seal when properly installed in the application for which it was designed. Please remember that the performance of a bolted joint is not solely dependent on the gasket itself, but on a combination of variables, many of which are outside the control of the gasket manufacturer. Experience has shown that leakage is not necessarily a sole indication of a faulty gasket, but is more likely to be the result of improper installation, assembly or bolting practices, damaged flanges, or a combination of the myriad of variables associated in a bolted gasketed assembly. When installing the gasket the following are to be considered:

Gasket Quality

Obviously gasket quality is important. Always deal with reputable suppliers and/or manufacturers who are capable of high quality products and sound technical support.

NEVER INSTALL A PREVIOUSLY USED GASKET!

Flange Surfaces

The condition of flange surfaces, as well as the proper flange material selection play an important part in achieving a leak-free joint assembly. Assure that the following are within acceptable limits:

- Surface finish
- Flatness
- Parallelism
- Waviness
- Surface imperfections

For optimum gasket performance Flexitallic recommends that the flange surface finishes listed in the table on page 45 be used for the respective gasket selected. To assure proper and even compression of the gasket we recommend that parallelism be within 0.2 mm (0.008”), flatness and waviness are kept at better than 0.2 mm (0.008”). We suggest that the allowable imperfections do not exceed the depth of the surface finish grooves, and that any radial marks are no deeper than the depth of the flange surface finish and less than 50% in length of the overall gasket sealing surface width.

Fasteners

It is important that the proper studs/bolts and nuts are selected to assure joint integrity. Improper selection of these may compromise the entire joint assembly. The following list is to be considered when selecting fasteners:

- Type
- Grade
- Class
- Proper material
- Appropriate coating or plating
- Correct stud/bolt length

See the table on page 52 for temperature rating of stud/bolt grades.

Assembly

In an effort to achieve a high degree of success in attaining a leak-free joint several steps are required. It is imperative that a regimented bolt up procedure is applied. As a minimum the following is suggested:

- Install a new gasket on the gasket seating surface and bring the mating flange in contact with the gasket.
- Do not apply any compounds on the gasket or gasket seating surfaces.
- Install all bolts, making sure that they are free of any foreign matter, and well lubricated. Lubricate nut bearing surfaces as well. (Lubrication will not be required for PTFE coated fasteners.)
- Run-up all nuts finger tight.
- Develop the required bolt stress or torque incrementally in a minimum of four steps in a crisscross pattern. The initial pre-stress should be no more than 30% of the final required bolt stress. After following this sequence, a final tightening should be performed bolt-to-bolt to ensure that all bolts have been evenly stressed.

Note: The use of hardened washers will enhance the joint assembly by reducing the friction due to possible galling of the nut bearing surfaces.

Gasket Installation

For critical applications a more sophisticated method for bolt up may be considered such as heating rods, bolt tensioners, or ultrasonic extensometer.

Bolting Up Sequence

Stage 1 - Torque bolts up to approximately 30% of the final torque value following the diametrically opposed sequence specified in table on page 56.

Stage 2 - Repeat Stage 1, increasing the torque value to approximately 60% of the final torque value.

Stage 3 - Repeat Stage 2, increasing the torque value to the final required torque value.

Stage 4 - A final tightening should be performed following an adjacent bolt-to-bolt sequence to ensure that all bolts have been evenly stressed.

Note: See Page 46 for bolt torque sequence.

Surface Finish Requirements

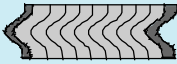
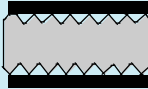
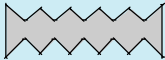
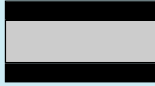
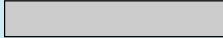
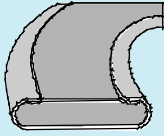
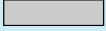
Gasket Description	Gasket Cross Section	Flange Surface Finish Microinch RMS	Flange Surface Finish Micrometer Ra
Spiral Wound Gaskets		125 - 250	3.2 - 6.3
Flexpro Gaskets		125 - 250	3.2 - 6.3
Metallic Serrated Gaskets		63 MAX	1.6 MAX
MRG		125 - 250	3.2 - 6.3
Solid Metal Gaskets		63 MAX	1.6 MAX
Metal Jacketed Gaskets		100 - 125	2.5 MAX
Soft Cut Sheet Gaskets		Mat'l < 1.5MM Thick 125 - 250	Mat'l < 1.5mm Thick 3.2 - 6.3
		Mat'l ≥ 1.5mm Thick 125 - 500	Mat'l ≥ 1.5mm Thick 3.2 - 12.5

Important - Under no circumstances should flange sealing surfaces be machined in a manner that tool marks would extend radially across the sealing surface. Such tool marks are practically impossible to seal regardless of the type of gasket used.

Bolt Torque Sequence

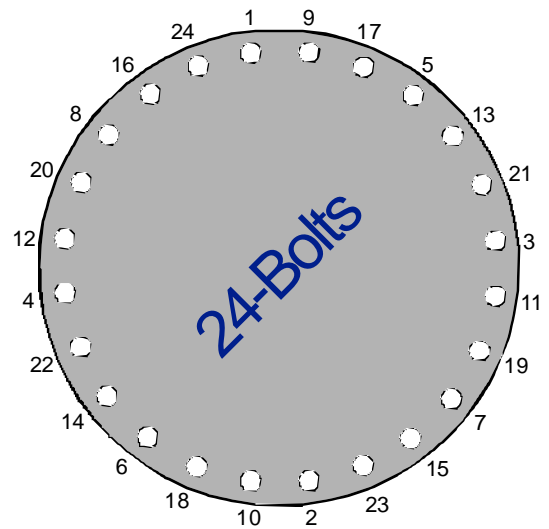
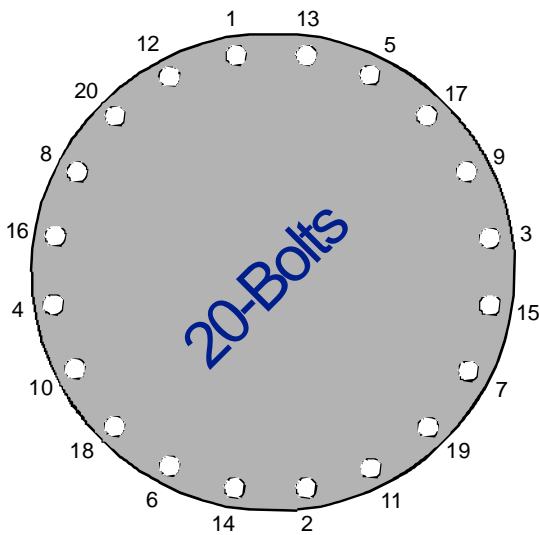
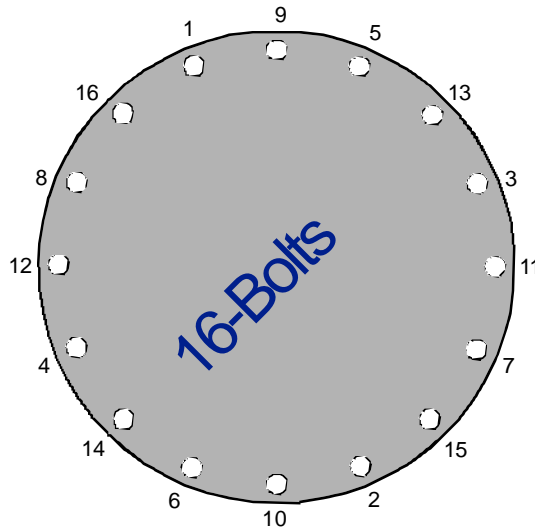
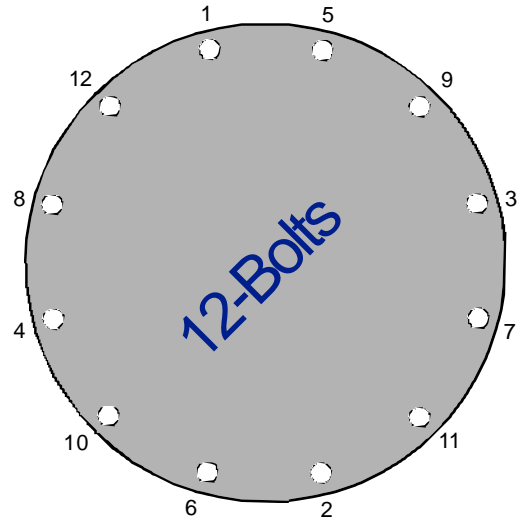
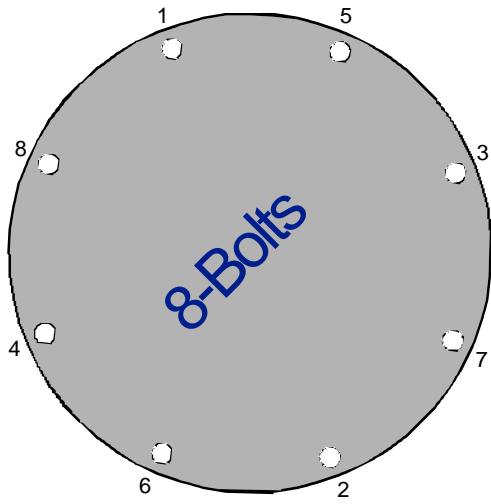

Troubleshooting

Good Preparation Ensures Good Performance

- Handle with care
- Keep in package
- Protect from damage and the weather
- Stack; don't hang
- Check flange surfaces for correct finish, blemishes, flatness, etc.
- Verify that proper stud material is being used
- Check condition of studs and nuts
- If washers are used they must be hardened
- Lubricate threads and bearing surface of nuts
- Don't apply any compounds or pastes on the gasket
- Use the correct, new gasket
- Don't secure the gasket to the flange with duct tape
- Use a cross bolting pattern in incremental steps; then go bolt-to-bolt
- Apply sufficient load



Troubleshooting

Joint Leakage

Often as not, when joint leakage occurs, a simple examination of the used gasket can determine the cause of failure. Firstly, always ensure that the spent gasket is correct to specification.

The Used Gasket . . . Telltale Signals of Trouble

Gasket Features	Observation	Possible Cause	Possible Remedy
Metal Windings	Asymmetrical compression and/or flattening of the lands of the chevron	Smooth and/or Dissimilar surface finish	Apply recommended surface finish 125/250 Ra. Use inner and outer rings. Place gasket in a groove
	Corrosion	Improper metal selection	Select metal compatible for the media
	Severe discoloration, cracking	Improper metal selection Exceeding temperature limit	Select proper metal
	Impingement or mechanical damage	Gasket wrongly sized Improper installation	Redesign gasket or use alternative gasket Improve installation and/or Procedure
Filler	Extreme discoloration Corrosion	Filler material incompatible with media or process	Select filler material compatible with media/process and temperature
	Oxidation	Exceed temperature limit Incompatible with media	
Thickness	Uneven compression	Flange waviness Flange out of parallel Flange rotation Improper installation and/or procedures	Machine flanges to recommended flatness and parallelism. Reduce bolt stress and/or compensate for rotational effects. Improve installation procedures
	Over-compression	Improper gasket selection Improper joint geometry	Use inner and/or outer rings Redesign joint geometry
	Insufficient compression	Improper installation Improper gasket stiffness insufficient bolt load Improper joint geometry	Improve installation Use proper constructed gasket Improve joint geometry
Gasket face surfaces	Leak path scoring	Foreign matter	Proper clean up of flanges and/or gaskets
	Transfer or imprint of flange surface finish	Improper surface finish	Assess finish and re-machine flanges to proper finish
	Micro imperfections, dings, scratches, interrupted surfaces	Foreign matter, tool marks on flanges, hardware, i.e. set screws or other implements	Re-machine and/or repair flanges. Remove any obstruction or interrupted surfaces
	Topical residue, smearing	Use of adhesives, grease compounds or tape as a means of gasket positioning or perceived performance enhancement	<u>Do Not</u> use any compounds, paste, grease or tape or any foreign substances. Note: Use of a light spray of adhesive is permissible for holding the gasket in place if needed
Mechanical Damage	Buckling of the sealing element	Omitting the use of an inner ring. Smooth flange surface finish. Bolt up inconsistencies. Extreme temperatures. Over-compression	Use inner rings. Assess surface finish. Reduce bolt loads to acceptable stresses. Use alternative gasket, i.e. Flexpro
	Excessive dishing, cupping indentations and yielding of outer ring	Excessive bolt load. Outer guide ring engaging bolts	Reduce bolt load to acceptable stresses. Concentric gasket installation

Metallic Gasket Materials

Material	Trade Name	Description	Temperature Range	Hardness Value (Brinell)	Comments
Carbon Steel	-	Commercial Quality Sheet Forged or Rolled Steel Often referred to as Soft Iron or Armco	-50 to 540°C (-58 to 1000°F)	120 max - 90 max for solid metal gaskets	For General applications only.
316	-	An 18-12 Chromium/Nickel Austenitic Stainless Steel, containing approx. 2% molybdenum content for high temperature strength.	815°C max (1500°F)	160 max	Excellent corrosion resistance Subject to stress corrosion cracking and intergranular corrosion in the presence of certain media Carbide precipitation may occur above 540°C
316L	-	Variation of 316, carbon content reduced to 0.03% maximum	815°C max (1500°F)	160 max	Reduced possibilities of stress Corrosion cracking and intergranular corrosion due to reduced carbon content
304	-	An 18-8 chromium/nickel austenitic stainless steel	540°C max (1000°F)	160 max	Excellent corrosion resistance Subject to stress corrosion cracking and intergranular corrosion at elevated temperatures
304L	-	Variation of 304. Carbon content reduced to 0.03% maximum	540°C max 1000°F	160 max	Reduced possibilities of stress. Corrosion cracking and intergranular corrosion due to reduced carbon content
317	-	An 18-13 chromium/nickel 3% molybdenum austenitic stainless steel	815°C max *1500°F)	160 max	Reduced possibilities of stress Corrosion cracking and intergranular corrosion due to reduced carbon content
321	-	An 18-10 chromium/nickel austenitic stainless steel with a titanium addition	870°C max (1600°F)	160 max	Is subject to stress corrosion Reduced possibilities of intergranular corrosion
347	-	An 18-10 chromium/nickel austenitic stainless steel with the addition of columbium (niobium)	870°C max (1600°F)	160 max	Similar properties as 321. High temperature resistance
410	-	A 13% chrom, 0.15% carbon martensitic stainless alloy	850°C max (1560°F)	170 max	Excellent high temperature strength/corrosion properties. Excellent resistance to oxidation, nitriding and carborization
Titanium	Titanium	High Purity Titanium material	1095°C max (2000°F)	Approx 215	Excellent high temperature Corrosion resistance Outstanding in oxidizing medias
Alloy 600	Inconel 600®	A 70% nickel, 15% chromium, 8% Iron alloy steel	1095°C max (2000°F)	150 max	Excellent high temperature strength/corrosion properties Excellent resistance to oxidation Nitriding and carborization
Alloy 625	Inconel 625®	A nickel/chromium alloy with substantial additions of molybdenum & columbium (niobium)	1095°C max (2000°F)	200 max	Outstanding corrosion resistance in a wide range of acid, neutral and alkaline environments
Alloy 800	Incoloy 800®	A 32% nickel, 20% chromium, 46% iron alloy steel	1095°C max (2000°F)	200 max	Excellent high temperature resistance
Alloy 825	Incoloy 825®	A nickel, chromium, iron, molybdenum and copper alloy steel	1095°C max (2000°F)	150 max	High resistance to hot acid conditions and outstanding resistance to stress corrosion cracking.

Metallic Gasket Materials

Material	Trade Name	Description	Temperature Range	Hardness Value (Brinell)	Comments
Alloy 200	Nickel 200	Commercially pure (99.6%) wrought nickel	760°C max (1400°F)	110 max	Highly resistant to various reducing chemicals and caustic alkalies.
Alloy 400	Monel [®] 400	A 67% nickel/30% copper alloy steel	820°C max (1500°F)	150 max	High resistance to hydrofluoric acid.
Alloy B2	Hastelloy [®] B2	A nickel/molybdenum alloy steel	1095°C max (2000°F)	200 max	Excellent chemical resistance to hydrochloric acid, sulfuric, acetic and phosphoric acids.
Alloy C276	Hastelloy [®] C276	A nickel/chromium/molybdenum alloy steel	1095°C max (2000°F)	200 max	Excellent corrosion resistance to both oxidizing and reducing media.
Alloy 20	Carpenter 20	An iron/chromium alloy steel	760°C max (1400°F)	160 max	Specifically developed for applications requiring resistance to sulfuric acid.
Alloy x - 750	Inconel [®] x-750	A nickel/chromium/iron alloy steel	1095°C max (2000°F)	-	Precipitation hardenable high resistance steel.
Aluminum	-	Commercially pure wrought aluminum	425°C max (800°F)	Approx 35	Excellent ductility and workability.
Brass		Commercial copper/zinc alloy	260°C max (500°F)	Approx 60	General corrosion resistance.
Copper		Commercially pure copper	315°C max (600°F)	Approx 80	General corrosion resistance.

Other materials include, tantalum, zirconium, platinum, gold, phosphor and bronze.

Useful Material Data

Stainless Steel Materials - Worldwide Equivalents

USA	UK	DIN	FRANCE	ITALY	SPAIN	JAPAN	SWEDEN
AISI/SAE	BS	DIN / W.-Nr	AFNOR	UNI	UNE	JIS	SS
304	304 S 15	X5CrNi 18 9 / 1.4301	Z6CN 18.09	X5CrNi 18 10	X5CrNi 18 10	SUS 304	2332
304L	304 S 12	X2CrNi 18 9 / 1.4306	Z2CN 18.10	X2CrNi 18 11	X2CrNi 19 10	SUS 304L	2352 2333
309	309 S 24	X15CrNi Si 20 12 / 1.4828	Z15CNS 20.12	-	X15CrNiSi20 12	SUH 309	-
310	-	X15CrNi Si 25 20 / 1.4841	Z12CNS 25.20	X16CrNiSi25 20	X15CrNiSi 25 20	SUH 310	-
316	316 S 16	X5CrNiMo 18 10 / 1.4401	Z6CND 17.11	X5CrNiMo 17 12	X5CrNiMo 17 12	SUS 316	2347
316L	316 S 11 316 S 12	X2CrNiMo 18 10 / 1.4404	Z2CND 18.13	X2CrNiMo 17 12	X2CrNiMo 17 12	SUS 316L	2348
316Ti	320 S 31 320 S 17	X10CrNiMoTi 18 10 / 1.4571	Z6CNDT 17.12	X6CrNiMoTi1712	X6CrNiMoTi1712	-	2350
321	321 S 12	X10CrNiTi 18 19 / 1.4541	Z6CNT 18.10	X6CrTi 18 11	X7CrNiTi 18 11	SUS 321	2337
347	347 S 51	X10CrNiNb 18 9 / 1.4550	Z6CNNb 18.10	X6CrNiNb 18 11	X7CrNiNb 18 11	SUS 347	2338
410	410 S 21	X10Cr13 / 1.4006	Z12 C13	X12 Cr13	X12 Cr13	SUS 410	2302

Bolting Data

Yield Strength (ksi) vs Temperature

SPEC	GRADE	TEMPERATURE °C/°F							
		20/70	205/400	315/600	425/800	540/1000	650/1200	760/1400	815/1500
ASTM A193	B6	85	76	72					
	B7	75-105	65-92	60-85	53-74				
	B8-CL1	30	21	18	17				
	B16	85-105	79-98	75-93	67-83				
ASTM A320	L7, L7A	105	92	84	73				
ASTM A453	660	85	82	81	80				
BS 4882	Nimonic B80A	90						73	
ASTM B446	Inconel 625	60							50
ASTM B637	Inconel 718	150						107	

Elastic Modulus (X 10⁶ psi) vs Temperature

SPEC	GRADE	TEMPERATURE °C/°F								
		-130/-200	20 / 70	205/400	315/600	425/800	540/1000	650/1200	760/1400	815/1500
ASTM A193	B6	30.7	29.2	27.3	26.1	24.7				
	B7	31.0	29.7	27.9	26.9	25.5				
	B8-CL1	29.7	28.3	26.5	25.3	24.1				
	B16	31.0	29.7	27.9	26.9	25.5				
ASTM A320	L7	31.0	29.7	27.9	26.9	25.5				
ASTM A453	660	29.7	28.3	26.5	25.3	24.1				
BS 4882	Nimonic B80A		31.2						>22.7	
ASTM B446	Inconel 625	30.2								22.6
ASTM B637	Inconel 718	29.0							22.3	

Bolting Data

Design Stress Values (ksi) vs Temperature

SPEC	GRADE	TEMPERATURE °C/°F										
		345/650	370/700	400/750	425/800	455/850	480/900	510/950	540/1000	565/1050	595/1100	
ASTM A193	B6	21.2	21.2	21.2	19.6	15.6	12.0					
	B7 *	25.0	25.0	23.6	21.0	17.0	12.5	8.5	4.5			
	B7M *	20.0	20.0	20.0	18.5	16.2	12.5	8.5	4.5			
	B8-CL1	11.2	11.0	10.8	10.5	10.3	10.1	9.9	9.7	9.5		
	B16	25.0	25.0	25.0	25.0	23.5	20.5	16.0	11.0	6.3	2.8	
ASTM A320	L7	20.0	20.0	20.0	20.0	16.2	12.5	8.5	4.5			
ASTM A453	660	20.2	20.1	20.0	19.9	19.9	19.9	19.8	19.8			

* For Bolt Diameters £ 2-1/2"

Please note that the above values are for reference purposes only. Values should be extracted from ASME or BS 5500.

Recommended Working Temperatures of Bolt Materials

MATERIAL	TEMPERATURE °C/°F	
	MIN.	MAX.
Carbon Steel	-30/-20	300/570
B7	-30/-20	400/750
L7	-100/-150	400/750
B6	-30/-20	510/950
B8	-200/-325	580/1075
B16	-30/-20	525/975
B17/660	-30/-20	650/1200
B80A	-250/-420	760/1400
Inconel 625	-250/-420	815/1500
Inconel 718	-250/-420	760/1400

Stress Retention Properties of Bolt Materials

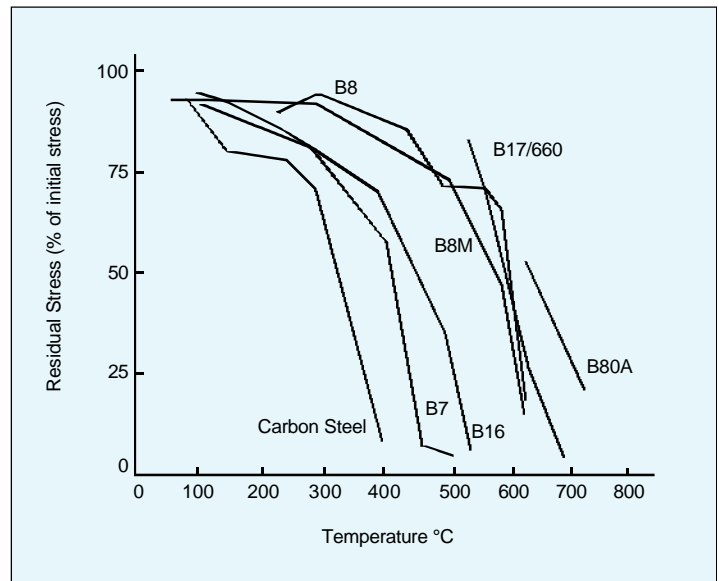

Stress relaxation behavior of various bolting materials showing percentage of initial stress retained at temperature

Useful Technical Data

Bolting Data for ASME B16.5 & BS 1560 Flanges

NOMINAL PIPE SIZE	CLASS 150				CLASS 300				CLASS 400				CLASS 600			
	FLANGE DIA.	NO. OF BOLTS	BOLT DIA.	B.C. DIA.	FLANGE DIA.	NO. OF BOLTS	BOLT DIA.	B.C. DIA.	FLANGE DIA.	NO. OF BOLTS	BOLT DIA.	B.C. DIA.	FLANGE DIA.	NO. OF BOLTS	BOLT DIA.	B.C. DIA.
1/4	3-3/8	4	1/2	2-1/4	3-3/8	4	1/2	2-1/4	3-3/8	4	1/2	2-1/4	3-3/8	4	1/2	2-1/4
1/2	3-1/2	4	1/2	2-3/8	3-3/4	4	1/2	2-5/8	3-3/4	4	1/2	2-5/8	3-3/4	4	1/2	2-5/8
3/4	3-7/8	4	1/2	2-3/4	4-5/8	4	5/8	3-1/4	4-5/8	4	5/8	3-1/4	4-5/8	4	5/8	3-1/4
1	4-1/4	4	1/2	3-1/8	4-7/8	4	5/8	3-1/2	4-7/8	4	5/8	3-1/2	4-7/8	4	5/8	3-1/2
1-1/4	4-5/8	4	1/2	3-1/2	5-1/4	4	5/8	3-7/8	5-1/4	4	5/8	3-7/8	5-1/4	4	5/8	3-7/8
1-1/2	5	4	1/2	3-7/8	6-1/8	4	3/4	4-1/2	6-1/8	4	3/4	4-1/2	6-1/8	4	3/4	4-1/2
2	6	4	5/8	4-3/4	6-1/2	8	5/8	5	6-1/2	8	5/8	5	6-1/2	8	5/8	5
2-1/2	7	4	5/8	5-1/2	7-1/2	8	3/4	5-7/8	7-1/2	8	3/4	5-7/8	7-1/2	8	3/4	5-7/8
3	7-1/2	4	5/8	6	8-1/4	8	3/4	6-5/8	8-1/4	8	3/4	6-5/8	8-1/4	8	3/4	6-5/8
3-1/2	8-1/2	8	5/8	7	9	8	3/4	7-1/4	9	8	7/8	7-1/4	9	8	7/8	7-1/4
4	9	8	5/8	7-1/2	10	8	3/4	7-7/8	10	8	7/8	7-7/8	10-3/4	8	7/8	8-1/2
5	10	8	3/4	8-1/2	11	8	3/4	9-1/4	11	8	7/8	9-1/4	13	8	1	10-1/2
6	11	8	3/4	9-1/2	12-1/2	12	3/4	10-5/8	12-1/2	12	7/8	10-5/8	14	12	1	11-1/2
8	13-1/2	8	3/4	11-3/4	15	12	7/8	13	15	12	1	13	16-1/2	12	1-1/8	13-3/4
10	16	12	7/8	14-1/4	17-1/2	16	1	15-1/4	17-1/2	16	1-1/8	15-1/4	20	16	1-1/4	17
12	19	12	7/8	17	20-1/2	16	1-1/8	17-3/4	20-1/2	16	1-1/4	17-3/4	22	20	1-1/4	19-1/4
14	21	12	1	18-3/4	23	20	1-1/8	20-1/4	23	20	1-1/4	20-1/4	23-3/4	20	1-3/8	20-3/4
16	23-1/2	16	1	21-1/4	25-1/2	20	1-1/4	22-1/2	25-1/2	20	1-3/8	22-1/2	27	20	1-1/2	23-3/4
18	25	16	1-1/8	22-3/4	28	24	1-1/4	24-3/4	28	24	1-3/8	24-3/4	29-1/4	20	1-5/8	25-3/4
20	27-1/2	20	1-1/8	25	30-1/2	24	1-1/4	27	30-1/2	24	1-1/2	27	32	24	1-5/8	28-1/2
24	32	20	1-1/4	29-1/2	36	24	1-1/2	32	36	24	1-3/4	32	37	24	1-7/8	33

NOMINAL PIPE SIZE	CLASS 900				CLASS 1500				CLASS 2500			
	FLANGE DIA.	NO. OF BOLTS	BOLT DIA.	B.C. DIA.	FLANGE DIA.	NO. OF BOLTS	BOLT DIA.	B.C. DIA.	FLANGE DIA.	NO. OF BOLTS	BOLT DIA.	B.C. DIA.
1/2	4-3/4	4	3/4	3-1/4	4-3/4	4	3/4	3-1/4	5-1/4	4	3/4	3-1/2
3/4	5-1/8	4	3/4	3-1/2	5-1/8	4	3/4	3-1/2	5-1/2	4	3/4	3-3/4
1	5-7/8	4	7/8	4	5-7/8	4	7/8	4	6-1/4	4	7/8	4-1/4
1-1/4	6-1/4	4	7/8	4-3/8	6-1/4	4	7/8	4-3/8	7-1/4	4	1	5-1/8
1-1/2	7	4	1	4-7/8	7	4	1	4-7/8	8	4	1-1/8	5-3/4
2	8-1/2	8	7/8	6-1/2	8-1/2	8	7/8	6-1/2	9-1/4	8	1	6-3/4
2-1/2	9-5/8	8	1	7-1/2	9-5/8	8	1	7-1/2	10-1/2	8	1-1/8	7-3/4
3	9-1/2	8	7/8	7-1/2	10-1/2	8	1-1/8	8	12	8	1-1/4	9
4	11-1/2	8	1-1/8	9-1/4	12-1/4	8	1-1/4	9-1/2	14	8	1-1/2	10-3/4
5	13-3/4	8	1-1/4	11	14-3/4	8	1-1/2	11-1/2	16-1/2	8	1-3/4	12-3/4
6	15	12	1-1/8	12-1/2	15-1/2	12	1-3/8	12-1/2	19	8	2	14-1/2
8	18-1/2	12	1-3/8	15-1/2	19	12	1-5/8	15-1/2	21-3/4	12	2	17-1/4
10	21-1/2	16	1-3/8	18-1/2	23	12	1-7/8	19	26-1/2	12	2-1/2	21-1/4
12	24	20	1-3/8	21	26-1/2	16	2	22-1/2	30	12	2-3/4	24-3/8
14	25-1/4	20	1-1/2	22	29-1/2	16	2-1/4	25	-	-	-	-
16	27-3/4	20	1-5/8	24-1/4	32-1/2	16	2-1/2	27-3/4	-	-	-	-
18	31	20	1-7/8	27	36	16	2-3/4	30-1/2	-	-	-	-
20	33-3/4	20	2	29-1/2	38-3/4	16	3	32-3/4	-	-	-	-
24	41	20	2-1/2	35-1/2	46	16	3-1/2	39	-	-	-	-

Dimensions in inches

Useful Technical Data

Facing Dimensions for ASME B16.5 & BS 1560 Flanges Class 150, 300, 400, 600, 900, 1500 and 2500

Nominal Pipe Size	Outside Diameter See Note (3)			I.D. of Large & Small Tongue See Notes (3) & (5)	Outside Diameter See Note (3)			I.D. of Large & Small Groove See Note (3) See Note (5)	Height		Depth of Groove or Female
	Raised Face, Lapped, Large Male, & Large Tongues See Note (5)	Small Male See Notes (4) & (5)	Small Tongue See Note (5)		Large Female & Large Groove See Note (5)	Small Female See Note (4) See Note (5)	Small Groove See Note (5)		Raised Face Class 150 & 300 See Note (1)	Raised Face Large & Small Male & Tongue Class 400, 600, 900 1500 & 2500 See Note (2)	
1/2	1-3/8	23/32	1-3/8	1	1-7/16	25/32	1-7/16	15/16	1/16	1/4	3/16
3/4	1-11/16	15/16	1-11/16	1-5/16	1-3/4	1	1-3/4	1-1/4	1/16	1/4	3/16
1	2	1-3/16	1-7/8	1-1/2	2-1/16	1-1/4	1-15/16	1-7/16	1/16	1/4	3/16
1-1/4	2-1/2	1-1/2	2-1/4	1-7/8	2-9/16	1-9/16	2-5/16	1-13/16	1/16	1/4	3/16
1-1/2	2-7/8	1-3/4	2-1/2	2-1/8	2-15/16	1-13/16	2-9/16	2-1/16	1/16	1/4	3/16
2	3-5/8	2-1/4	3-1/4	2-7/8	3-11/16	2-5/16	3-5/16	2-13/16	1/16	1/4	3/16
2-1/2	4-1/8	2-11/16	3-3/4	3-3/8	4-3/16	2-3/4	3-13/16	3-5/16	1/16	1/4	3/16
3	5	3-5/16	4-5/8	4-1/4	5-1/16	3-3/8	4-11/16	4-3/16	1/16	1/4	3/16
3-1/2	5-1/2	3-13/16	5-1/8	4-3/4	5-9/16	3-7/8	5-3/16	4-11/16	1/16	1/4	3/16
4	6-3/16	4-5/16	5-11/16	5-3/16	6-1/4	4-3/8	5-3/4	5-1/8	1/16	1/4	3/16
5	7-5/16	5-3/8	6-13/16	6-5/16	7-3/8	5-7/16	6-7/8	6-1/4	1/16	1/4	3/16
6	8-1/2	6-3/8	8	7-1/2	8-9/16	6-7/16	8-1/16	7-7/16	1/16	1/4	3/16
8	10-5/8	8-3/8	10	9-3/8	10-11/16	8-7/16	10-1/16	9-5/16	1/16	1/4	3/16
10	12-3/4	10-1/2	12	11-1/4	12-13/16	10-9/16	12-1/16	11-3/16	1/16	1/4	3/16
12	15	12-1/2	14-1/4	13-1/2	15-1/16	12-9/16	14-5/16	13-7/16	1/16	1/4	3/16
14	16-1/4	13-3/4	15-1/2	14-3/4	16-5/16	13-13/16	15-9/16	14-11/16	1/16	1/4	3/16
16	18-1/2	15-3/4	17-5/8	16-3/4	18-9/16	15-13/16	17-11/16	16-11/16	1/16	1/4	3/16
18	21	17-3/4	20-1/8	19-1/4	21-1/16	17-13/16	20-3/16	19-3/16	1/16	1/4	3/16
20	23	19-3/4	22	21	23-1/16	19-13/16	22-1/16	20-15/16	1/16	1/4	3/16
24	27-1/4	23-3/4	26-1/4	25-1/4	27-5/16	23-13/16	26-5/16	25-3/16	1/16	1/4	3/16

Dimensions in inches

Notes:

- (1) Regular facing for Class 150 and 300 steel flanged fittings and companion flange standards is a 1/16" raised face included in the minimum flange thickness dimensions. A 1/16" raised face may be supplied also on the Class 400, 600, 900, 1500, and 2500 flange standards, but it must be added to the minimum flange thickness.
- (2) Regular facing for Class 400, 600, 900, 1500, and 2500 flange thickness dimensions.
- (3) Tolerance of plus or minus 0.016", 1/64" is allowed on the inside and outside diameters of all facings.
- (4) For small male and female joints care should be taken in the use of these dimensions to insure that pipe used is thick enough to permit sufficient bearing surface to prevent the crushing of the gasket. The dimensions apply particularly on lines where the joint is made on the end of the pipe. Screwed companion flanges for small male and female joints are furnished with plain face and are threaded with American Standard Locknut Thread.
- (5) Gaskets for male-female and tongue-groove joints shall cover the bottom of the recess with minimum clearances taking into account the tolerances prescribed in Note 3.

Torque Required To Produce Bolt Stress

The torque or turning effort required to produce a certain stress in bolting is dependent upon a number of conditions, some of which are:

1. Diameter of bolt
2. Type and number of threads on bolt
3. Material of bolt
4. Condition of nut bearing surfaces
5. Lubrication of bolt threads and nut bearing surfaces

Generally, standard FLEXITALLIC spiral wound gaskets will require that bolting is stressed to 30,000 psi for proper gasket seating. However, it is a common industry practice to apply a bolt stress equivalent to 50% of yield of commonly used alloy steel bolts, (A 193 B7), to seat standard spiral wound gaskets. The applied force provides for some compensation in bolt up inconsistencies, creep relaxation, and other variables associated with flange make up.

Torque Data For Use with Alloy Steel Stud Bolts *Load in Pounds on Stud Bolts When Torque Loads Are Applied*

Nominal Diameter of Bolt (Inches)	Number of Threads (Per Inch)	Diameter at Root of Thread (Inches)	Area at Root of Thread Sq. Inch	Stress					
				30,000 psi		45,000 psi		60,000 psi	
				Torque Ft/Lbs	Load Lbs	Torque Ft/Lbs	Load Lbs	Torque Ft/Lbs	Load Lbs
1/4	20	.185	.027	4	810	6	1215	8	1620
5/16	18	.240	.045	8	1350	12	2025	16	2700
3/8	16	.294	.068	12	2040	18	3060	24	4080
7/16	14	.345	.093	20	2790	30	4185	40	5580
1/2	13	.400	.126	30	3780	45	5670	60	7560
9/16	12	.454	.162	45	4860	68	7290	90	9720
5/8	11	.507	.202	60	6060	90	9090	120	12120
3/4	10	.620	.302	100	9060	150	13590	200	18120
7/8	9	.731	.419	160	12570	240	18855	320	25140
1	8	.838	.551	245	16530	368	24795	490	33060
1-1/8	8	.963	.728	355	21840	533	32760	710	43680
1-1/4	8	1.088	.929	500	27870	750	41805	1000	55740
1-3/8	8	1.213	1.155	680	34650	1020	51975	1360	69300
1-1/2	8	1.338	1.405	800	42150	1200	63225	1600	84300
1-5/8	8	1.463	1.680	1100	50400	1650	75600	2200	100800
1-3/4	8	1.588	1.980	1500	59400	2250	89100	3000	118800
1-7/8	8	1.713	2.304	2000	69120	3000	103680	4000	138240
2	8	1.838	2.652	2200	79560	3300	119340	4400	159120
2-1/4	8	2.088	3.423	3180	102690	4770	154035	6360	205380
2-1/2	8	2.338	4.292	4400	128760	6600	193140	8800	257520
2-3/4	8	2.588	5.259	5920	157770	8880	236655	11840	315540
3	8	2.838	6.324	7720	189720	11580	284580	15440	379440
3-1/4	8	3.088	7.490	10000	224700	15000	337050	20000	449400
3-1/2	8	3.338	8.750	12500	262500	18750	393750	25000	525000
3-3/4	8	3.589	10.11	15400	303300	23150	454950	30900	606600

Note: Torque values are based on well lubricated alloy steel bolting.

Ordering FLEXITALLIC Gaskets for Special Flange Designs

In order for FLEXITALLIC to design a gasket suitable for the application, it is imperative that complete details be submitted for review. The information we require is the following:

1. Type of Flange facing
2. Dimensions of the gasket seating surfaces
3. Number, size and material of bolts
4. Bolt circle diameter
5. Operating pressure & temperature (Process material if known)
6. Hydrostatic test pressure
7. Initial bolt pre-stress
8. Customer preference on gasket materials

FLEXITALLIC supplies engineering data sheets at no cost on which this information may be submitted. As a gasket manufacturer, it is impossible for us to review every flange design to make certain that flange rotation and flange stresses are within allowable limits defined in the Code. We proceed on the assumption the design engineer has followed the design criteria established by the ASME Boiler Code and that the flanges are sufficiently rigid under the most severe condition to preclude the possibility the gasket could become unloaded either during operating conditions or hydrostatic test conditions. We are aware that most flange designers do not take into consideration flange rotation at test conditions prior to finalizing his design. We also, of a practical necessity, must assume the bolt material being used is adequate for all conditions including operating pressure at operating temperature and hydrostatic test pressure at ambient temperature.

The use of the optimum material for bolts is a very complex subject and we suggest reviewing currently available technical literature for guidance in the proper selection of bolting material for piping and pressure vessel applications.

GASKET ENGINEERING DATA

Company _____ Date _____
 Address _____ Order/Inquiry No. _____

SERVICE CONDITIONS	CUSTOMER PREFERENCE	FLANGE DESCRIPTION	FLANGE DIMENSIONS
Operating Pressure _____ psi	Gasket Material _____	Figure _____	A _____" T _____
Operating Temp _____ °F	Gasket Filler _____	Welding Neck _____	B _____" No. of Bolts _____
Substance to be sealed _____	Ring Metal _____	Lap Joint _____	C _____" Size of Bolts _____
Unusual condition _____	Gasket Style _____	Slip On _____	D _____" Bolt Material _____
		Blind _____	
			Material _____
			Threaded _____
			Sketch (Back) _____
			Print Attached _____
			Surface Finish _____rms

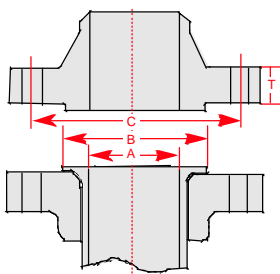

Raised Face or Van Stone

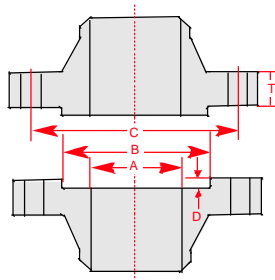

Male and Female

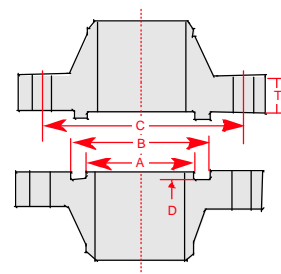

Tongue and Groove

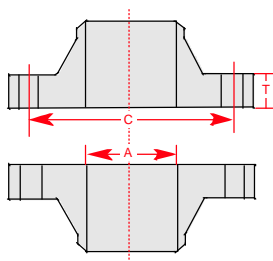

Smooth Face

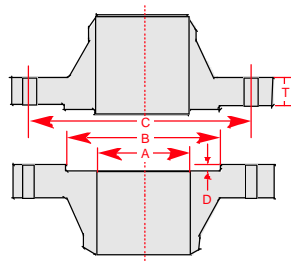

Male & Female with Spigot

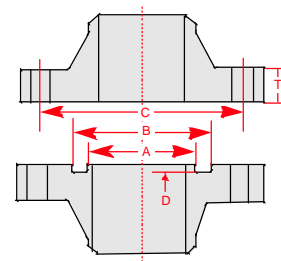

Groove to Flat Face

Ordering FLEXITALLIC Gaskets for Special Flange Designs

Overall Dimensional Limits

In general, the only limits on the dimensions of heat exchanger gaskets are the limits of sizes of material available.

Note: In addition to the above information, drawings of your application are always helpful for proper dimensioning of gaskets.

Dimensions

- Outside Diameter
- Inside Diameter
- Shape
- Style Number
- Thickness
- Material (metal or metal and filler)
- Rib width
- Distance from centerline of gasket to centerline of ribs
- Radii
- Specify number, placement, bolt circle radius and size of bolt holes

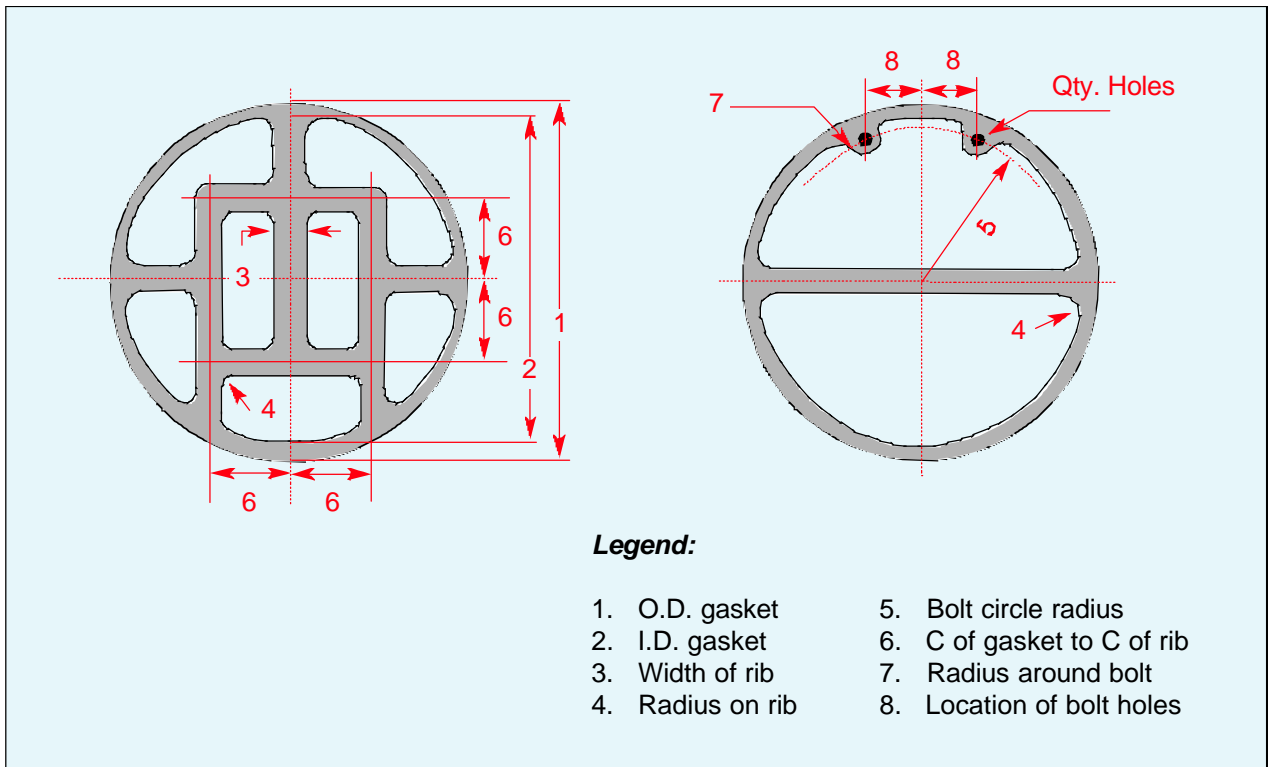

Metric Unit Conversions

To Convert From:	To SI Units:	Multiply By:
Length		
mil	mm	0.0254
in	mm	25.4
in	cm	2.54
ft	m	0.3048
Area		
in ²	cm ²	6.4516
ft ²	m ²	0.0929
Volume		
gal	l	3.7854l
gal	m ³	0.0038

To Convert From:	To SI Units:	Multiply By:
Force		
lbf	N	4.4482
kgf	N	9.8066
Weight		
oz	g	28.3495
oz	kg	0.0283
lb	g	453.5924
lb	kg	0.4536
Density		
oz/in ³	g/cm ³	1.73
g/cm ³	kg/m ³	1000.
lb/ft ³	kg/m ³	16.0185

To Convert From:	To SI Units:	Multiply By:
Pressure		
psi	Pa	6894.757
psi	kPa	6.8947
psi	bar	0.069
psi	MPa	0.0069
N/m ²	Pa	1.000
Torque		
in lb	Nm	0.113
ft lb	Nm	1.3558
Adhesion		
lb/in	KN/m	0.1751

Temperature Conversion

Conversion Formulas: $C = \frac{5}{9}(F-32)$, $F = \frac{9}{5}(C)+32$

Fahrenheit to Centigrade

-350 to 6		7 to 49		50 to 92		93 to 440		450 to 870		880 to 2000	
F	C	F	C	F	C	F	C	F	C	F	C
-350	-212	7	-13.9	50	10.0	93	33.9	450	232	880	471
-340	-207	8	-13.3	51	10.6	94	34.4	460	238	890	477
-330	-201	9	-12.8	52	11.1	95	35.0	470	243	900	482
-320	-196	10	-12.2	53	11.7	96	35.6	480	249	910	488
-310	-190	11	-11.7	54	12.2	97	36.1	490	254	920	493
-300	-184	12	-11.1	55	12.8	98	36.7	500	260	930	499
-290	-179	13	-10.6	56	13.3	99	37.2	510	266	940	504
-280	-173	14	-10.0	57	13.9	100	37.8	520	271	950	510
-273	-169	15	-9.4	58	14.4	110	43	530	277	960	516
-270	-168	16	-8.9	59	15.0	120	49	540	282	970	521
-260	-162	17	-8.3	60	15.6	130	54	550	288	980	527
-250	-157	18	-7.8	61	16.1	140	60	560	293	990	532
-240	-151	19	-7.2	62	16.7	150	66	570	299	1000	538
-230	-146	20	-6.7	63	17.2	160	71	580	304	1020	549
-220	-140	21	-6.1	64	17.8	170	77	590	310	1040	560
-210	-134	22	-5.6	65	18.3	180	82	600	316	1060	571
-200	-129	23	-5.0	66	18.9	190	88	610	321	1080	582
-190	-123	24	-4.4	67	19.4	200	93	620	327	1100	593
-180	-118	25	-3.9	68	20.0	210	99	630	332	1120	604
-170	-112	26	-3.3	69	20.6	212	100	640	338	1140	616
-160	-107	27	-2.8	70	21.1	220	104	650	343	1160	627
-150	-101	28	-2.2	71	21.7	230	110	660	349	1180	638
-140	-96	29	-1.7	72	22.2	240	116	670	354	1200	649
-130	-90	30	-1.1	73	22.8	250	121	680	360	1220	660
-120	-84	31	-0.6	74	23.3	260	127	690	366	1240	671
-110	-79	32	0.0	75	23.9	270	132	700	371	1260	682
-100	-73	33	0.6	76	24.4	280	138	710	377	1280	693
-90	-68	34	1.1	77	25.0	290	143	720	382	1300	704
-80	-62	35	1.7	78	25.5	300	149	730	388	1350	732
-70	-57	36	2.2	79	26.1	310	154	740	393	1400	760
-60	-51	37	2.8	80	26.7	320	160	750	399	1450	788
-50	-46	38	3.3	81	27.2	330	166	760	404	1500	816
-40	-40	39	3.9	82	27.8	340	171	770	410	1550	843
-30	-34	40	4.4	83	28.3	350	177	780	416	1600	871
-20	-29	41	5.0	84	28.9	360	182	790	421	1650	899
-10	-23	42	5.6	85	29.4	370	188	800	427	1700	927
0	-17.8	43	6.1	86	30.0	380	193	810	432	1750	954
1	-17.2	44	6.7	87	30.6	390	199	820	438	1800	982
2	-16.7	45	7.2	88	31.1	400	204	830	443	1850	1010
3	-16.1	46	7.8	89	31.7	410	210	840	449	1900	1038
4	-15.6	47	8.3	90	32.2	420	215	850	454	1950	1066
5	-15.0	48	8.9	91	32.8	430	221	860	460	2000	1093
6	-14.4	49	9.4	92	33.3	440	227	870	466		

The content of this Dimensional and Order Guide relates to Flexitallic's products as supplied. The information contained herein is given in good faith, but no liability will be accepted in relation to same. The revision of products, pursuant to Flexitallic's policy of continuous development, as well as the acquisition of further information, may necessitate revisions to parts or all of this document. Flexitallic's Technical Sales Department will be pleased to update customers, on request. As the company's products are used for a multiplicity of purposes, and as Flexitallic has no control over the method of their application or use, Flexitallic must exclude all conditions or warranties, express or implied, as to their products and/or their fitness for any particular purpose. Any technical cooperation between the Company and its customers is given for the customer's assistance only, and without liability on the part of Flexitallic.

Flexitallic L.P. guarantees that any product of its manufacture, which, upon examination by a Flexitallic representative, is found to be defective in either workmanship or material whereby it is suitable under proper usage and service for the purpose for which it was designed, will be replaced or repaired free of charge including transportation charges but not cost of installation or, at our option, the purchase price will be refunded. The products are not guaranteed as to performance under any specific service nor for any specific period of time. The sale of our products under any other warranty or guarantee express or implied is not authorized by the company.

WARNING:

Properties/applications shown throughout this brochure are typical. Your specific application should not be undertaken without independent study and evaluation for suitability. For specific application recommendations consult Flexitallic. Failure to select the proper sealing products could result in property damage and/or serious personal injury.

Performance data published in this brochure has been developed from field testing, customer field reports and/or in-house testing.

While the utmost care has been used in compiling this brochure, we assume no responsibility for errors. Specifications subject to change without notice. This edition cancels all previous issues. Subject to change without notice.

Flexitallic is a registered trademark for gaskets, seals and other products of Flexitallic.